

High Voltage Varnished Leaded Capacitors

TCL Series



ELECTRICAL SPECIFICATIONS

DIELECTRIC	NPO	C4xx	X7R
Dielectric code	1	4	2
Maximum ΔC/°C over temperature range without voltage	NA	NA	±15%
Temperature coefficient	(0±30) ppm/°C	(-2,200±500) ppm/°C	NA
Aging	None	None	≤ 2.5% per decade hour
Operating temperature	-55°C to +125°C		
Rated voltage (U_{RC})	200 V _{DC} to 10,000 V _{DC}	200 V _{DC} to 5,000 V _{DC}	200 V _{DC} to 10,000 V _{DC}
Dielectric withstanding voltage	2.5 U _{RC} for U _{RC} ≤ 500 V _{DC} 1.6 U _{RC} for U _{RC} ≥ 1,000 V _{DC} Extended range: 2 U _{RC} for U _{RC} ≤ 500 V _{DC} 1.3 U _{RC} for U _{RC} ≥ 1,000 V _{DC}	2.5 U _{RC} for U _{RC} = 200 V _{DC} 2 U _{RC} for U _{RC} = 500 V _{DC} 1.5 U _{RC} for U _{RC} = 1,000 V _{DC} 1.4 U _{RC} for U _{RC} > 1,000 V _{DC} Extended range: 1.5 U _{RC} for U _{RC} ≤ 500 V _{DC} 1.2 U _{RC} for U _{RC} ≥ 1,000 V _{DC}	2.5 U _{RC} for U _{RC} = 200 V _{DC} 2 U _{RC} for U _{RC} = 500 V _{DC} 1.5 U _{RC} for U _{RC} = 1,000 V _{DC} 1.2 U _{RC} for U _{RC} > 1,000 V _{DC} Extended range: 1.5 U _{RC} for U _{RC} ≤ 500 V _{DC} 1.2 U _{RC} for U _{RC} ≥ 1,000 V _{DC}
Capacitance	at 1MHz for C ≤ 1,000pf at 1kHz for C > 1,000pf		at 1kHz
Dissipation factor	≤ 0.015 (150/C + 7)% at 1MHz for C ≤ 50pf ≤ 0.15% at 1MHz for 50pf < C ≤ 1,000pf ≤ 0.15% at 1kHz for C > 1,000pf		≤ 0.10% at 1kHz ≤ 2.5% at 1kHz
Insulation resistance at 25°C under U_{RC} for U_{RC} ≤ 500 V under 500 V_{DC} for U_{RC} > 500 V	≥ 100,000 MΩ for C ≤ 10nf ≥ 1,000 MΩ.μF for C > 10nf		≥ 20,000 MΩ for C ≤ 25nf ≥ 500 MΩ.μF for C > 25nf

FEATURES

- Multilayer chip ceramic capacitors
- NPO, C4xx and X7R dielectrics
- Capacitance range: 10pf to 39 μF
- Voltage range: 200 V_{DC} to 10,000 V_{DC}

PHYSICAL CHARACTERISTICS

CONSTRUCTION

Varnished radial leaded chip capacitors for through-hole circuits. Models suited to applications for reduced size is required with minimum exposure to external constraint, or to assemblies potted by the user.

MARKING

Series, capacitance value, tolerance, rated voltage clear, date code.

HIGH VOLTAGE

HOW TO ORDER

TCL	1	82	W	F	680pF	10%	4,000 V	B
Series	Dielectric code	Exxelia size code	RoHS compliant	Quality level	Capacitance	Tolerance	Rated voltage	Reliability level
TCL = Varnished radial leaded capacitor	1 = NPO 2 = X7R 4 = C4xx	79 90 80 91 81 82 83 84 89 85 87 88	- = No RoHS W = RoHS compliant	- = standard quality level F = Hi-Rel quality: screening in accordance with Exxelia specification	Capacitance value in clear	<u>NPO dielectric:</u> ±1% ±2% ±5% ±10% ±20% <u>C4xx dielectric:</u> ±2% ±5% ±10% ±20% <u>X7R dielectric:</u> ±10% ±20%	200 V 500 V 1,000 V 1,500 V 2,000 V 3,000 V 4,000 V 5,000 V 7,500 V 10,000 V Intermediary and higher voltages available: contact your sales representative.	For F parts only. Acc. to Exxelia spec. - T5 T6 See page 15

TCL Series

High Voltage Varnished Leaded Capacitors

DIMENSIONS in inches (mm)

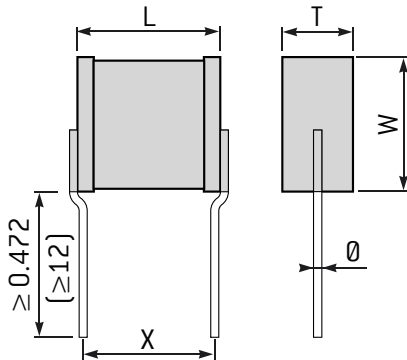

STANDARD RATINGS

		Exxelia size code			79			90			80			91			81			82																	
Dimensions inches (mm)	L max.	0.237 (6)			0.237 (6)			0.276 (7)			0.276 (7)			0.355 (9)			0.394 (10)																				
	W max.	0.197 (5)			0.296 (7.5)			0.276 (7)			0.296 (7.5)			0.296 (7.5)			0.394 (10)																				
	T max.	0.138 (3.5)			0.138 (3.5)			0.2kV up to 3kV: 0.118 (3) 4kV-5kV: 0.150 (3.8)			0.2kV up to 3kV: 0.158 (4) 4kV-5kV: 0.197 (5)			0.2kV up to 3kV: 0.158 (4) 4kV: 0.197 (5) 5kV: 0.237 (6)			0.2kV up to 3kV: 0.158 (4) 4kV: 0.197 (5) 5kV: 0.237 (6)																				
	Ø ± 10%	0.024 (0.6)			0.024 (0.6)			0.024 (0.6)			0.024 (0.6)			0.031 (0.8)			0.031 (0.8)																				
	X	0.2 ± 0.020 (5.08 ± 0.5)			0.2 ± 0.020 (5.08 ± 0.5)			0.2 ± 0.020 (5.08 ± 0.5)			0.2 ± 0.020 (5.08 ± 0.5)			0.3 ± 0.020 (7.62 ± 0.5)			0.4 ± 0.020 (10.16 ± 0.5)																				
Dielectric		NPO		C4xx		X7R		NPO		C4xx		X7R		NPO		C4xx		X7R		NPO		C4xx		X7R													
Exxelia ceramic code		1		4		2		1		4		2		1		4		2		1		4		2													
Min. Capacitance value		10pF		27pF		100pF		10pF		33pF		150pF		10pF		33pF		150pF		15pF		47pF		150pF		18pF		56pF		150pF		33pF		82pF		330pF	
Rated voltage (U _{RC})	0.2kV	Standard	5.6nF	120nF	220nF	12nF	220nF	470nF	12nF	220nF	390nF	15nF	330nF	560nF	18nF	390nF	820nF	33nF	680nF	1.5µF																	
		Extended	18nF	-	470nF	27nF	-	-	22nF	-	1µF	39nF	-	-	56nF	-	1.8µF	100nF	-	2.7µF																	
	0.5kV	Standard	3.3nF	22nF	47nF	6.8nF	47nF	100nF	5.6nF	47nF	100nF	6.8nF	68nF	150nF	8.2nF	82nF	220nF	22nF	120nF	390nF																	
		Extended	10nF	39nF	150nF	18nF	68nF	-	18nF	68nF	270nF	22nF	100nF	-	27nF	120nF	560nF	68nF	220nF	1µF																	
	1kV	Standard	1.8nF	6.8nF	15nF	2.7nF	12nF	24nF	2.2nF	12nF	22nF	3.3nF	18nF	33nF	3.9nF	22nF	47nF	10nF	39nF	68nF																	
		Extended	5.6nF	10nF	27nF	8.2nF	15nF	-	6.8nF	15nF	56nF	10nF	22nF	-	12nF	27nF	120nF	33nF	56nF	220nF																	
	1.5kV	Standard	820pF	2.7nF	5.6nF	1.2nF	5.6nF	10nF	1.5nF	5.6nF	10nF	2.2nF	8.2nF	15nF	2.7nF	10nF	18nF	4.7nF	18nF	33nF																	
		Extended	1.5nF	3.9nF	12nF	2.2nF	8.2nF	-	2.2nF	6.8nF	22nF	3.3nF	12nF	-	4.7nF	15nF	47nF	8.2nF	27nF	82nF																	
	2kV	Standard	390pF	1.5nF	3.3nF	680pF	2.7nF	5.6nF	470pF	2.7nF	5.6nF	820pF	4.7nF	6.8nF	1.2nF	5.6nF	10nF	3.3nF	10nF	18nF																	
		Extended	820pF	2.2nF	5.6nF	1.2nF	3.9nF	-	1nF	3.9nF	12nF	1.8nF	6.8nF	-	2.7nF	8.2nF	27nF	6.8nF	15nF	47nF																	
	3kV	Standard	180pF	680pF	1.2nF	180pF	1.2nF	2.2nF	220pF	1.2nF	2.2nF	330pF	1.8nF	3.3nF	470pF	2.2nF	3.9nF	820pF	3.9nF	6.8nF																	
		Extended	390pF	1nF	2.7nF	680pF	1.8nF	-	470pF	1.8nF	4.7nF	820pF	2.7nF	-	1nF	3.3nF	12nF	1.8nF	5.6nF	22nF																	
	4kV	Standard	100pF	330pF	680pF	120pF	680pF	1nF	150pF	820pF	1.2nF	220pF	1.2nF	1.8nF	390pF	1.5nF	2.7nF	680pF	3.3nF	4.7nF																	
		Extended	220pF	560pF	-	330pF	1nF	-	330pF	1.2nF	2.2nF	680pF	1.8nF	-	820pF	2.2nF	4.7nF	1.5nF	4.7nF	10nF																	
5kV	Standard	-	-	-	-	-	-	100pF	560pF	820pF	150pF	820pF	1nF	270pF	1nF	1.8nF	470pF	2.2nF	3.3nF																		
	Extended	-	-	-	-	-	-	220pF	820pF	1.5nF	320pF	1.2nF	-	560pF	1.5nF	3.3nF	1nF	2.7nF	6.8nF																		

High Voltage Varnished Leaded Capacitors

TCL Series

STANDARD RATINGS

		Exxelia size code			83			84			89			85			87			88																																			
Dimensions (mm)	L max.	0.473 (12)			0.63 (16)			0.642 (16.3)			0.729 (18.5)			1.182 (30)			1.674 (42.5)																																						
	W max.	0.493 (12.5)			0.493 (12.5)			0.619 (15.7)			0.689 (17.5)			0.886 (22.5)			0.827 (21)																																						
	T max.	0.2kV up to 3kV: 0.158 (4) 4kV: 0.197 (5) 5kV up to 10kV: 0.237 (6)			0.2kV up to 3kV: 0.158 (4) 4kV: 0.197 (5) 5kV up to 10kV: 0.237 (6)			0.2kV up to 3kV: 0.158 (4) 4kV: 0.197 (5) 5kV up to 10kV: 0.237 (6)			0.2kV up to 3kV: 0.158 (4) 4kV: 0.197 (5) 5kV up to 10kV: 0.237 (6)			0.2kV up to 3kV: 0.158 (4) 4kV: 0.197 (5) 5kV: 0.237 (6) 7.5kV up to 10kV: 0.256 (6.5)			0.2kV up to 3kV: 0.158 (4) 4kV: 0.197 (5) 5kV: 0.237 (6) 7.5kV up to 10kV: 0.256 (6.5)																																						
	Ø ± 10%	0.031 (0.8)			0.039 (1)			0.039 (1)			0.039 (1)			0.039 (1)			0.039 (1)																																						
	X	0.5 ± 0.020 (12.7 ± 0.5)			0.6 ± 0.020 (15.24 ± 0.5)			0.6 ± 0.020 (15.24 ± 0.5)			0.7 ± 0.020 (17.8 ± 0.5)			1.1 ± 0.020 (27.94 ± 0.5)			1.6 ± 0.020 (40.64 ± 0.5)																																						
Dielectric		NPO			C4xx			X7R			NPO			C4xx			X7R			NPO			C4xx			X7R																													
Exxelia ceramic code		1			4			2			1			4			2			1			4			2																													
Min. Capacitance value		10pF			180pF			270pF			22pF			270pF			390pF			27pF			390pF			560pF			47pF			470pF			1nF			120pF			1nF			2.2nF			150pF			1.8nF			2.7nF		
Rated voltage (U _{ric})	0.2kV	Standard	56nF	1.2µF	2.7µF	82nF	1.5µF	3.9µF	100nF	1.8µF	4.7µF	180nF	2.7µF	6.8µF	330nF	6.8µF	12µF	390nF	8.2µF	15µF																																			
		Extended	180nF	-	5.6µF	270nF	-	6.8µF	220nF	-	8.2µF	560nF	-	12µF	1µF	-	33µF	1.2µF	-	39µF																																			
	0.5kV	Standard	33nF	270nF	680nF	47nF	330nF	1µF	56nF	390nF	1.2µF	82nF	680nF	1.8µF	150nF	1.5µF	3.9µF	270nF	1.8µF	4.7µF																																			
		Extended	100nF	390nF	1.5µF	150nF	560nF	2.2µF	150nF	680nF	2.7µF	270nF	1µF	3.9µF	470nF	2.2µF	10µF	820nF	2.7µF	12µF																																			
	1kV	Standard	15nF	82nF	150nF	22nF	82nF	220nF	33nF	120nF	270nF	39nF	220nF	390nF	82nF	560nF	1µF	150nF	680nF	1.2µF																																			
		Extended	47nF	120nF	390nF	68nF	120nF	560nF	82nF	220nF	560nF	120nF	330nF	1µF	270nF	680nF	2.7µF	470nF	1µF	3.3µF																																			
	1.5kV	Standard	8.2nF	39nF	82nF	12nF	39nF	100nF	15nF	68nF	150nF	22nF	100nF	180nF	47nF	220nF	470nF	68nF	330nF	560nF																																			
		Extended	18nF	56nF	180nF	22nF	56nF	220nF	33nF	100nF	330nF	47nF	150nF	470nF	100nF	330nF	1.2µF	150nF	470nF	1.5µF																																			
	2kV	Standard	4.7nF	18nF	33nF	6.8nF	22nF	68nF	8.2nF	39nF	68nF	12nF	56nF	100nF	27nF	120nF	220nF	39nF	180nF	330nF																																			
		Extended	10nF	27nF	100nF	15nF	33nF	150nF	18nF	56nF	150nF	27nF	82nF	220nF	56nF	180nF	560nF	82nF	270nF	820nF																																			
	3kV	Standard	1.5nF	8.2nF	15nF	2.7nF	10nF	27nF	3.3nF	18nF	27nF	4.7nF	27nF	39nF	12nF	56nF	100nF	15nF	68nF	120nF																																			
		Extended	3.3nF	12nF	39nF	5.6nF	15nF	56nF	10nF	22nF	68nF	10nF	39nF	100nF	27nF	82nF	270nF	33nF	100nF	330nF																																			
	4kV	Standard	1.2nF	6.8nF	10nF	2.2nF	6.8nF	15nF	2.7nF	12nF	18nF	3.9nF	18nF	27nF	10nF	39nF	68nF	12nF	47nF	100nF																																			
		Extended	2.7nF	10nF	18nF	4.7nF	10nF	27nF	6.8nF	18nF	39nF	8.2nF	27nF	47nF	22nF	56nF	120nF	27nF	82nF	150nF																																			
	5kV	Standard	1nF	4.7nF	5.6nF	1.8nF	4.7nF	10nF	1.8nF	8.2nF	12nF	3.3nF	12nF	18nF	8.2nF	27nF	56nF	10nF	33nF	68nF																																			
		Extended	2.2nF	6.8nF	15nF	3.9nF	6.8nF	22nF	4.7nF	12nF	27nF	6.8nF	18nF	39nF	15nF	39nF	82nF	18nF	47nF	100nF																																			
	7.5kV	Standard	150pF	-	1.5nF	270pF	-	2.7nF	470pF	-	3.3nF	560pF	-	6.8nF	1.5nF	-	18nF	2.2nF	-	27nF																																			
		Extended	330pF	-	3.3nF	560pF	-	5.6nF	1.2nF	-	6.8nF	1.2nF	-	12nF	3.3nF	-	33nF	4.7nF	-	47nF																																			
	10kV	Standard	100pF	-	680pF	180pF	-	1.2nF	270pF	-	1.5nF	390pF	-	3.3nF	1nF	-	8.2nF	1.5nF	-	12nF																																			
		Extended	220pF	-	1.8nF	390pF	-	3.3nF	680pF	-	3.9nF	820pF	-	6.8nF	2.2nF	-	15nF	3.3nF	-	27nF																																			

HIGH VOLTAGE

Available capacitance values:
 NPO, C4xx dielectrics: E6, E12, E24 (see page 14). Specific values upon request.
 X7R dielectric: E6, E12 in standard (see page 14). Specific values upon request.
 The above table defines the standard products, other components may be built upon request.

General Information

High voltage multilayer ceramic capacitors designed by EXXELIA are adapted to applications in electronics such as high voltage power supplies and high circuits. Their multilayer construction offers significant size and space saving advantages. They are available in class 1 (NPO), class 2 (X7R) and C4xx (-2,200 ppm/°C) dielectrics versions complying with the main requirements of applicable standards. They are suited for use in commercial, industrial and High-Rel military and space circuits.

As standard products can't meet all the specificities of all applications, special applications may require specific features (higher voltage, burn-in, dimensions, coating, leading, marking...) not described in this catalogue. Based on our state-of-the-art technologies and our expertise, our Engineers may study at your request all special components to meet your application.

Please, consult us for more information.

NPO, X7R, C4xx: SELF-RESONANCE FREQUENCY VS CAPACITANCE

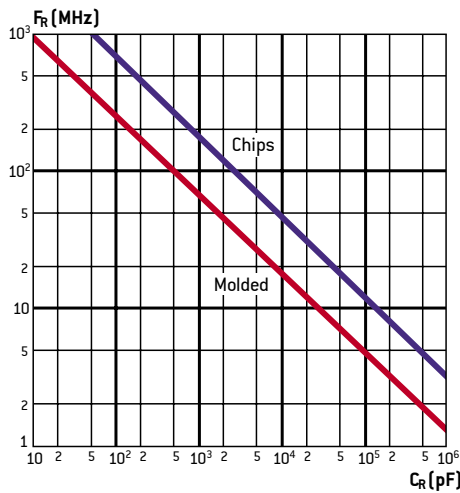

NPO/COG DIELECTRICS (CLASS 1)

Made of titanium oxide and other various selected oxides, they feature unique stability of all parameters under such constraints as operating time, temperature, voltage applied. For example, the quality factor remains very high over an extremely wide frequency range. As example, loss angle tangent value at 1MHz is typically in the order of 3.10⁻⁴. These characteristics make them compatible with steep-edge impulse mode without noticeable temperature rise. The different parameters and related variations are illustrated in figures below:

NPO: RELATIVE CAPACITANCE CHANGE VS TEMPERATURE

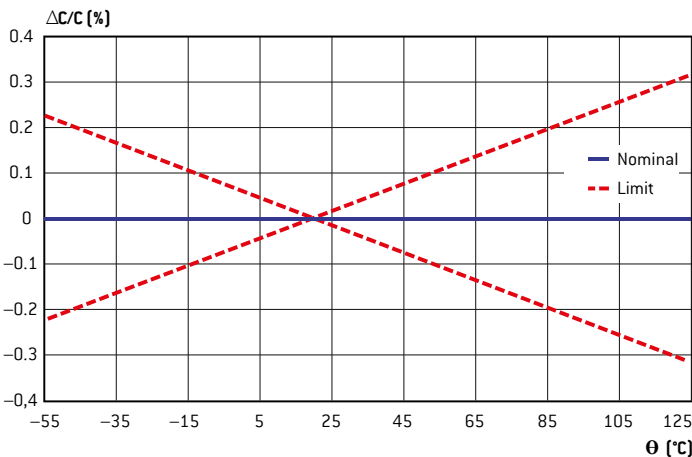

NPO: IMPEDANCE VS FREQUENCY

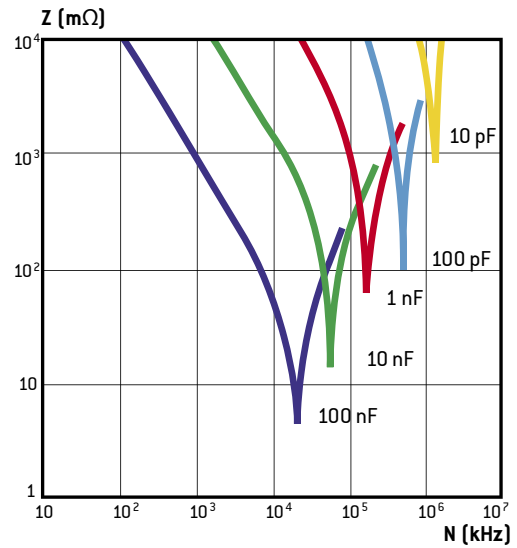

NPO: LOSS TANGENT VS TEMPERATURE

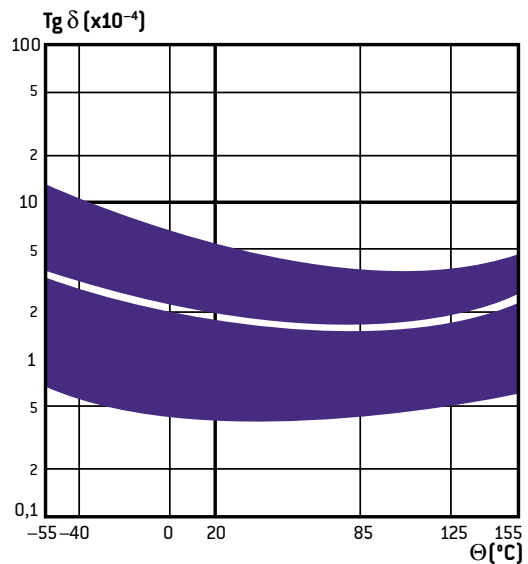

NPO: INSULATION RESISTANCE VS TEMPERATURE

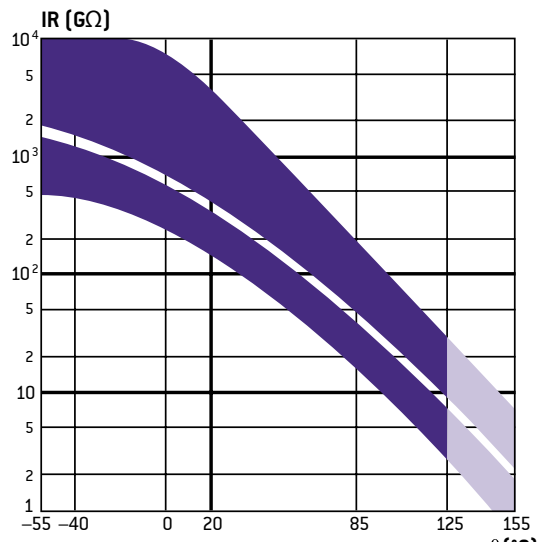

General Information

X7R DIELECTRICS (CLASS 2)

They are mainly made of barium titanate modified by various oxides to achieve the electrical properties required. A specific ceramic dielectric is used to achieve an excellent dielectric strength. High dielectric constant enables to achieve high capacitance values.

For optimum use, the specific properties of barium titanate in function of the different parameters must be taken into account.

See the variations illustrated in figures below:

CHANGE VS PERCENTAGE OF RATED VOLTAGE APPLIED

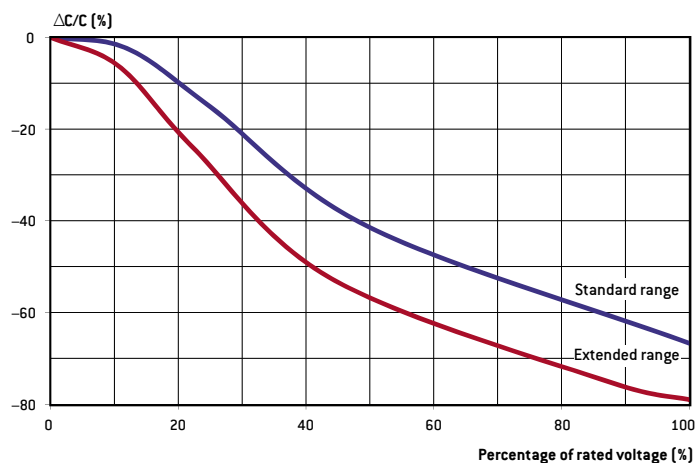

X7R: CAPACITANCE CHANGE VS TEMPERATURE

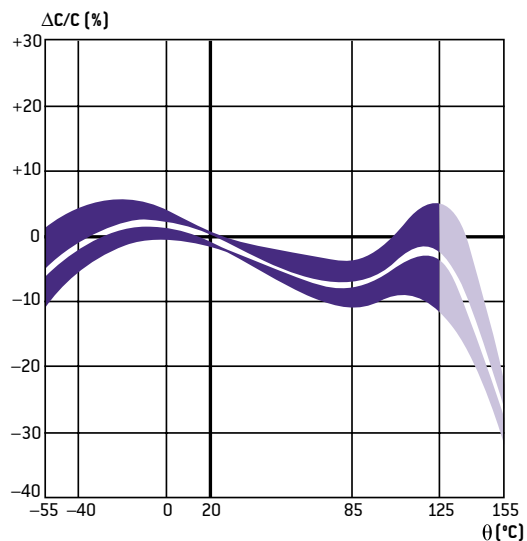

X7R: CAPACITANCE CHANGE VS FREQUENCY

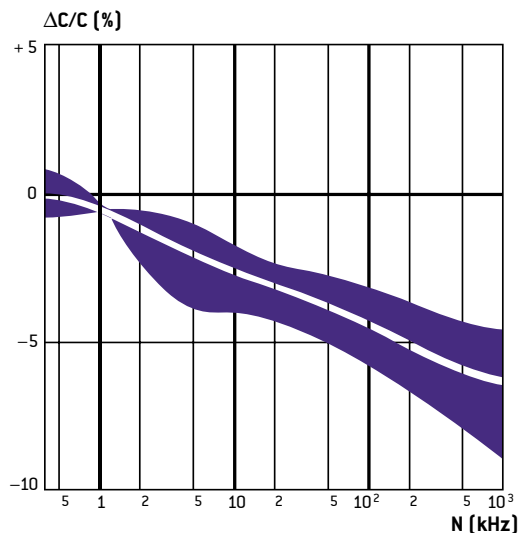

X7R: INSULATION RESISTANCE VS TEMPERATURE

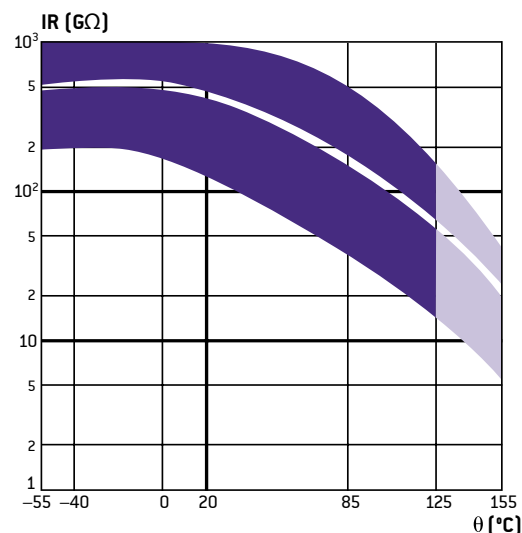

HIGH VOLTAGE

General Information

X7R: LOSS TANGENT CHANGE VS TEMPERATURE

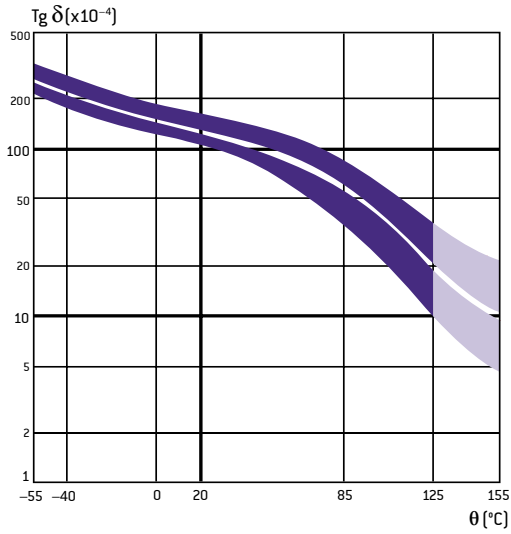

X7R: MAXIMUM ADMISSIBLE CURRENT VS FREQUENCY

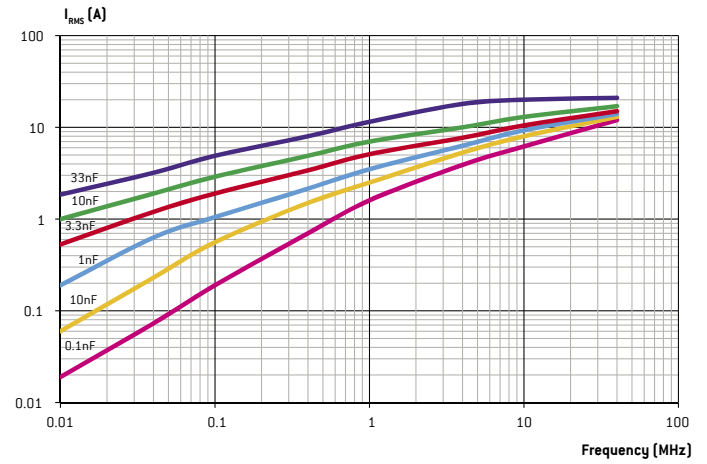

These typical curves are examples of admissible currents for one family of chip capacitors (size 3333). For other curves and products or for further information, please contact us.

Note: for the calculations, we have considered that the terminations are directly connected to an infinite heat sink. In other words, the thermal resistance of the circuit itself which depends on its type and design has not been taken into account. Moreover, the ambient temperature taken is 25°C.

X7R: LOSS TANGENT CHANGE VS FREQUENCY

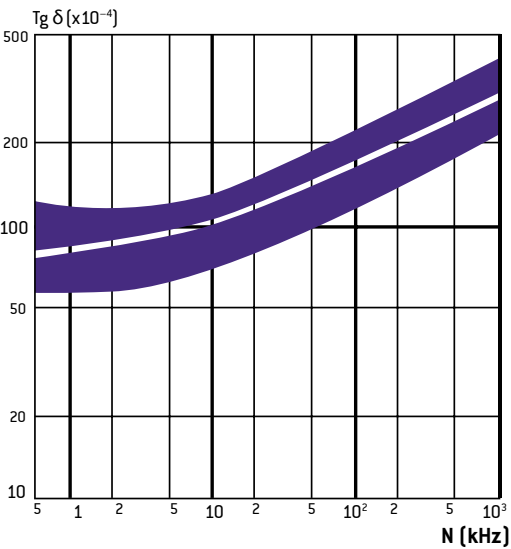

X7R: ESR VS FREQUENCY

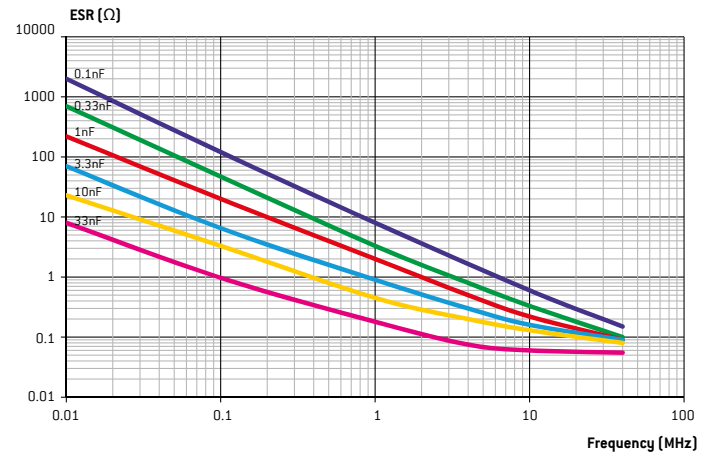

The ESR (Equivalent Serial Resistance) typical curves are given, here for SMD (chip) capacitors. Regarding the curves for the leaded capacitors, they are rather the same. Indeed, due to the resistivity of the raw material used and the wire diameters, the resistance of the wires is much lower than the ESR of the chips. So, in a first approach, their influence can be considered as negligible.

General Information

C4xx DIELECTRIC

This ceramic is a negative temperature coefficient dielectric [-2,200 ppm/°C]. Its advantage is that it combines the high dielectric constant of an X7R dielectric with the stability of an NPO dielectric. As the C4xx ceramic features low dissipation factor it is recommended for AC line filtering from 110 Vrms to 230 Vrms, 20 to 400 Hz, for high power RF at high voltage up to 5,000 V and for pulse applications.

C4xx: TEMPERATURE COEFFICIENT

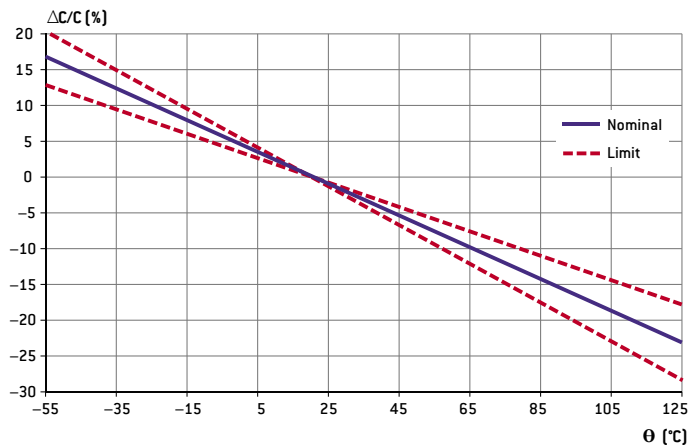

C4xx: VOLTAGE COEFFICIENT

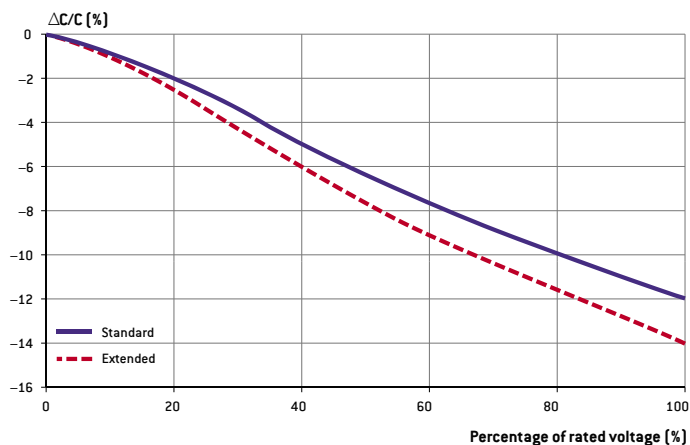

COMPARISON OF CAPACITANCE VALUE UNDER RATED VOLTAGE AT 125°C

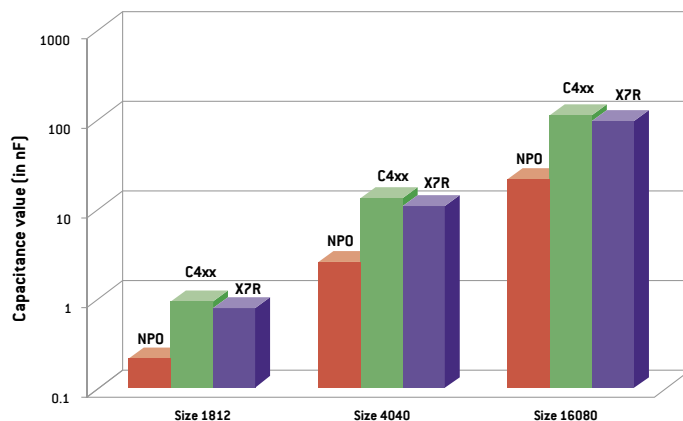

HIGH VOLTAGE

COMPARISON OF SELF-HEATING AT 400 Hz BETWEEN C4xx AND X7R DIELECTRICS

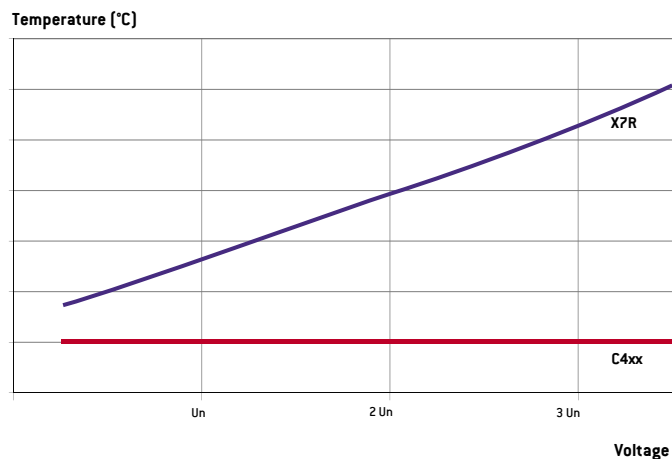

General Information

RECOMMENDED FOOTPRINTS

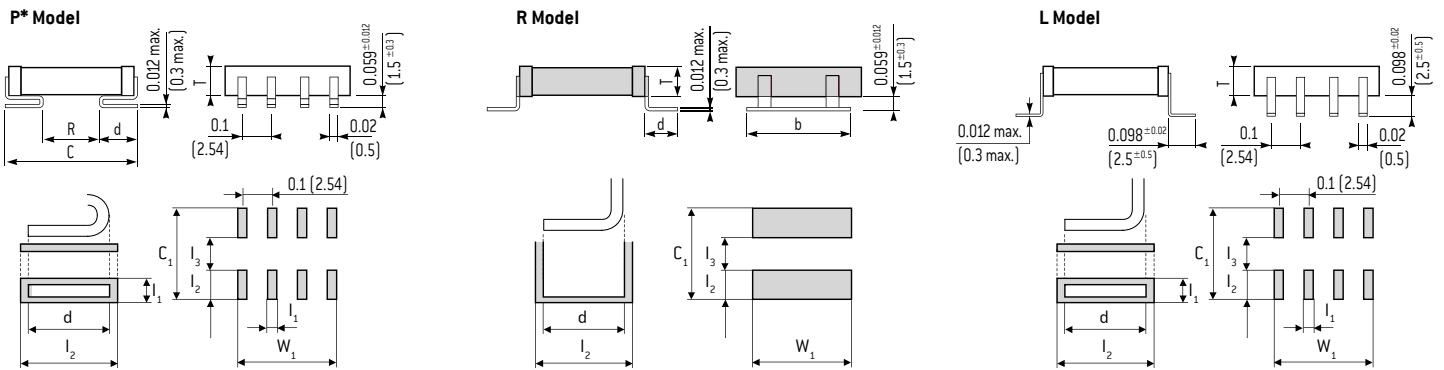

DIMENSIONS in inches (mm)

Exxelia size code	Lead shape	C max inches (mm)	Leads per side	d inches (mm)	b inches (mm)	C ₁ inches (mm)	W ₁ inches (mm)	I ₁ inches (mm)	I ₂ inches (mm)	I ₃ inches (mm)
90	P*	0.228 (5.8)	2	0.06 ± 0.012 (1.5 ± 0.3)	-	0.268 (6.8)	0.147 (3.74)	0.047 (1.2)	0.108 (2.75)	0.098 (2.5)
	L	0.394 (10)	2	0.098 ± 0.02 (2.5 ± 0.5)	-	0.433 (11)	0.147 (3.74)	0.047 (1.2)	0.152 (3.85)	0.130 (3.3)
	R	0.386 (9.8)	1	0.087 ± 0.008 (2.2 ± 0.2)	0.197 ± 0.02 (5 ± 0.5)	0.425 (10.8)	0.244 (6.2)	-	0.148 (3.75)	0.130 (3.3)
80	P*	0.276 (7)	2	0.06 ± 0.012 (1.5 ± 0.3)	-	0.315 (8)	0.147 (3.74)	0.047 (1.2)	0.108 (2.75)	0.098 (2.5)
	L	0.480 (12.2)	2	0.098 ± 0.02 (2.5 ± 0.5)	-	0.520 (13.2)	0.147 (3.74)	0.047 (1.2)	0.171 (4.35)	0.177 (4.5)
	R	0.433 (11)	1	0.087 ± 0.008 (2.2 ± 0.2)	0.197 ± 0.02 (5 ± 0.5)	0.472 (12)	0.244 (6.2)	-	0.148 (3.75)	0.177 (4.5)
91	P*	0.276 (7)	2	0.06 ± 0.012 (1.5 ± 0.3)	-	0.315 (8)	0.147 (3.74)	0.047 (1.2)	0.108 (2.75)	0.098 (2.5)
	L	0.480 (12.2)	2	0.098 ± 0.02 (2.5 ± 0.5)	-	0.520 (13.2)	0.147 (3.74)	0.047 (1.2)	0.171 (4.35)	0.177 (4.5)
	R	0.433 (11)	1	0.087 ± 0.008 (2.2 ± 0.2)	0.197 ± 0.02 (5 ± 0.5)	0.472 (12)	0.244 (6.2)	-	0.148 (3.75)	0.177 (4.5)
81	P*	0.315 (8)	2	0.087 ± 0.012 (2.2 ± 0.3)	-	0.354 (9)	0.147 (3.74)	0.047 (1.2)	0.108 (2.75)	0.138 (3.5)
	L	0.531 (13.5)	2	0.098 ± 0.02 (2.5 ± 0.5)	-	0.571 (14.5)	0.147 (3.74)	0.047 (1.2)	0.171 (4.35)	0.228 (5.8)
	R	0.484 (12.3)	1	0.087 ± 0.008 (2.2 ± 0.2)	0.197 ± 0.02 (5 ± 0.5)	0.524 (13.3)	0.244 (6.2)	-	0.148 (3.75)	0.228 (5.8)
82	P*	0.354 (9)	3	0.087 ± 0.012 (2.2 ± 0.3)	-	0.394 (10)	0.247 (6.28)	0.047 (1.2)	0.108 (2.75)	0.177 (4.5)
	L	0.587 (14.9)	3	0.098 ± 0.02 (2.5 ± 0.5)	-	0.626 (15.9)	0.247 (6.28)	0.047 (1.2)	0.171 (4.35)	0.283 (7.2)
	R	0.642 (16.3)	1	0.138 ± 0.008 (3.5 ± 0.2)	0.315 ± 0.02 (8 ± 0.5)	0.681 (17.3)	0.362 (9.2)	-	0.199 (5.05)	0.283 (7.2)
83	P*	0.472 (12)	4	0.087 ± 0.012 (2.2 ± 0.3)	-	0.512 (13)	0.347 (8.82)	0.047 (1.2)	0.118 (3)	0.276 (7)
	L	0.676 (17.16)	4	0.098 ± 0.02 (2.5 ± 0.5)	-	0.715 (18.16)	0.347 (8.82)	0.047 (1.2)	0.191 (4.85)	0.333 (8.46)
	R	0.731 (18.56)	1	0.138 ± 0.008 (3.5 ± 0.2)	0.315 ± 0.02 (8 ± 0.5)	0.770 (19.56)	0.362 (9.2)	-	0.219 (5.55)	0.333 (8.46)
84	P*	0.610 (15.5)	4	0.087 ± 0.012 (2.2 ± 0.3)	-	0.650 (16.5)	0.347 (8.82)	0.047 (1.2)	0.128 (3.25)	0.394 (10)
	L	0.815 (20.7)	4	0.098 ± 0.02 (2.5 ± 0.5)	-	0.854 (21.7)	0.347 (8.82)	0.047 (1.2)	0.191 (4.85)	0.472 (12)
	R	0.870 (22.1)	1	0.138 ± 0.008 (3.5 ± 0.2)	0.315 ± 0.02 (8 ± 0.5)	0.909 (23.1)	0.362 (9.2)	-	0.219 (5.55)	0.472 (12)
89	P*	0.630 (16)	5	0.087 ± 0.012 (2.2 ± 0.3)	-	0.669 (17)	0.347 (8.82)	0.047 (1.2)	0.128 (3.25)	0.413 (10.5)
	L	0.827 (21)	5	0.098 ± 0.02 (2.5 ± 0.5)	-	0.866 (22)	0.347 (8.82)	0.047 (1.2)	0.191 (4.85)	0.484 (12.3)
	R	0.882 (22.4)	1	0.138 ± 0.008 (3.5 ± 0.2)	0.315 ± 0.02 (8 ± 0.5)	0.921 (23.4)	0.362 (9.2)	-	0.219 (5.55)	0.484 (12.3)
85	P*	0.728 (18.5)	6	0.087 ± 0.012 (2.2 ± 0.3)	-	0.768 (19.5)	0.547 (13.9)	0.047 (1.2)	0.128 (3.25)	0.512 (13)
	L	0.925 (23.5)	6	0.098 ± 0.02 (2.5 ± 0.5)	-	0.965 (24.5)	0.547 (13.9)	0.047 (1.2)	0.191 (4.85)	0.583 (14.8)
	R	0.980 (24.9)	1	0.138 ± 0.008 (3.5 ± 0.2)	0.591 ± 0.02 (15 ± 0.5)	1.020 (25.9)	0.638 (16.2)	-	0.219 (5.55)	0.583 (14.8)
87	P*	1.260 (32)	6	0.087 ± 0.012 (2.2 ± 0.3)	-	1.299 (33)	0.547 (13.9)	0.047 (1.2)	0.128 (3.25)	0.945 (24)
	L	1.398 (35.5)	6	0.098 ± 0.02 (2.5 ± 0.5)	-	1.437 (36.5)	0.547 (13.9)	0.047 (1.2)	0.191 (4.85)	1.055 (26.8)
	R	1.453 (36.9)	1	0.138 ± 0.008 (3.5 ± 0.2)	0.591 ± 0.02 (15 ± 0.5)	1.492 (37.9)	0.638 (16.2)	-	0.219 (5.55)	1.055 (26.8)
88	P*	1.654 (42)	6	0.087 ± 0.012 (2.2 ± 0.3)	-	1.693 (43)	0.547 (13.9)	0.047 (1.2)	0.128 (3.25)	1.378 (35)
	L	1.831 (46.5)	6	0.098 ± 0.02 (2.5 ± 0.5)	-	1.870 (47.5)	0.547 (13.9)	0.047 (1.2)	0.191 (4.85)	1.488 (37.8)
	R	1.886 (47.9)	1	0.138 ± 0.008 (3.5 ± 0.2)	0.591 ± 0.02 (15 ± 0.5)	1.925 (48.9)	0.638 (16.2)	-	0.219 (5.55)	1.488 (37.8)

* For PL and PLS, add 0.098 in (2.5 mm) to d and I₂ and 0.197 in (5 mm) to C₁.

Ceramic Capacitors Technology

MLCC STRUCTURE

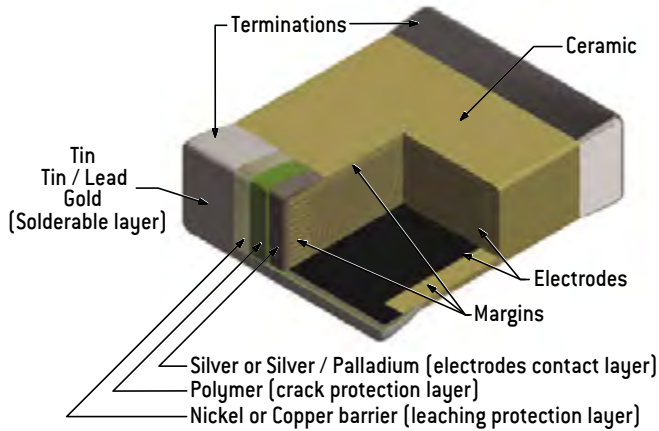

EQUIVALENT CIRCUIT

Capacitor is a complex component combining resistive, inductive and capacitive phenomena. A simplified schematic for the equivalent circuit is:

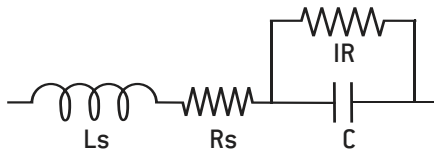

DIELECTRIC CHARACTERISTICS

Insulation Resistance (IR) is the resistance measured under DC voltage across the terminals of the capacitor and consists principally of the parallel resistance shown in the equivalent circuit. As capacitance values and hence the area of dielectric increases, the IR decreases and hence the product $[C \times IR]$ is often specified in $\Omega \cdot F$ or $M\Omega \cdot \mu F$.

The Equivalent Series Resistance (ESR) is the sum of the resistive terms which generate heating when capacitor is used under AC voltage at a given frequency (f) .

Dissipation factor (DF) is the ration of the apparent power input will turn to heat in the capacitor:

$$DF = 2\pi f C ESR$$

When a capacitor works under AC voltage, **heat power loss (P)**, expressed in Watt, is equal to:

$$P = 2\pi f C V_{rms}^2 DF$$

The series inductance (Ls) is due to the currents running through the electrodes. It can distort the operation of the capacitor at high frequency where the **impedance (Z)** is given as:

$$Z = R_s + j [L_s \cdot \omega - 1/(C \cdot \omega)] \text{ with } \omega = 2\pi f$$

When frequency rises, the capacitive component of capacitors is gradually canceled up to the resonance frequency, where :

$$Z = R_s \text{ and } L_s C \cdot \omega^2 = 1$$

Above this frequency the capacitor behaves like an inductor.

	P100	NPO	N2200 (C4xx)	BX	2C1	X7R
Dielectric material	Porcelain	Magnesium titanate or Neodymium baryum titanate	Barium zirconate titanate	Baryum titanate (BaTiO ₃)		
Dielectric constant	15 – 18	20 – 85	450	2,000 – 5,000		
Electrode technology	PME (Precious Metal Electrodes): Ag/Pd					
Capacitance variation between –55°C and +125°C without DC voltage	[100±30]ppm/°C	[0±30]ppm/°C	[–2,200±500] ppm/°C	±15%	±20%	±15%
Capacitance variation between –55°C and +125°C with DC rated voltage			0-15%	15%–25%	20%–30%	Not applicable
Piezo-electric effect	None		None	Yes		
Dielectric absorption	None		Few %	Few %		
Thermal shock sensitive	+		+	++		

Ceramic Capacitors Technology

MANUFACTURING STEPS

SLIP CASTING



A slurry, a mix of ceramic powder, binder and solvents, is poured onto conveyor belt inside a drying oven, resulting in a dry ceramic sheet.

ELECTRODE SCREEN PRINTING

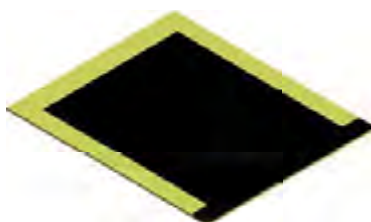

The electrode ink, made from a metal powder mixed with solvents, is printed onto the ceramic sheets using a screen printing process.

STACKING

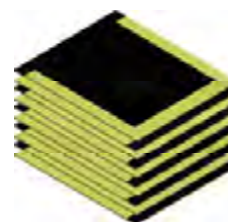

The sheets with electrode printed are stacked to create a multilayer structure.

TERMINATIONS

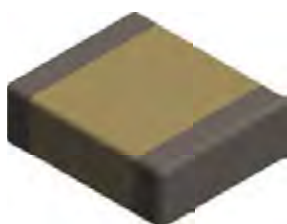

Each terminal of the capacitor is dipped in the termination ink, mix of metal powder, solvents and glass frit and the parts are fired in an oven.

SINTERING

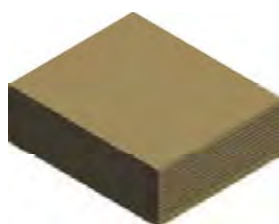

The parts are sintered in an oven with a precise temperature profile which is very important to the characteristics of the capacitors.

PRESSING

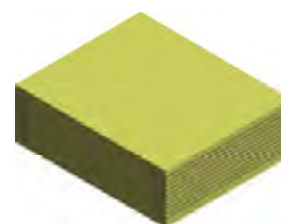

Pressure is applied to the stack to fuse all the separate layers, this created a monolithic structure.

TERMINATIONS PLATING

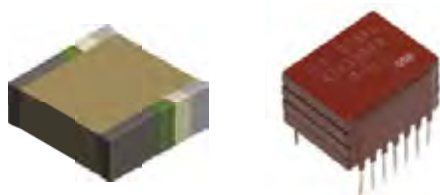

Stacking + leads soldering + encapsulation
[see pages 10-11]

FINAL TESTING

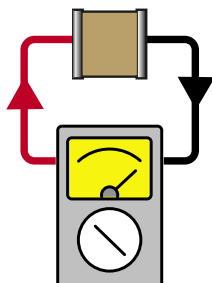

PACKAGING



User Guide

SMD TERMINATIONS

NON RoHS COMPLIANT	Code	RoHS COMPLIANT	Code	Recommended mounting process							Storage (months)*
				Magnetic	Epoxy bonding	Iron soldering	Wave soldering	Vapor phase soldering	Infrared soldering	Wire bonding	
Ag	Q	Ag	QW / P	No	•	•	•	•			18
Ag/Pd/Pt	-	Ag/Pd/Pt	W / A	No	•	•	•				24
Ag/Pd/Pt + dipped Sn/Pb 60/40	H	Ag/Pd/Pt + dipped Sn	HW	No		•					24
Ag + Ni + electrolytic Sn/Pb 95/5	C	Ag + Ni + electrolytic Sn	CW / S	Yes		•	•	•	•		18
Ag + Ni + electrolytic Sn/Pb 60/40	D	-	-	Yes		•	•	•	•		18
-	-	Ag + Cu + electrolytic Sn	C**	No		•	•	•	•		18
Ag + Ni + dipped Sn/Pb 60/40	E	-	-	Yes		•	•				24
Ag + Ni + Au	G	Ag + Ni + Au	GW	Yes	•	•	•	•	•	•	36
Ag + Polymer + Ni + Sn/Pb 95/5	YC	Ag + Polymer + Ni + Sn	YCW	Yes		•	•	•	•		18
Ag + Polymer + Ni + Sn/Pb 60/40	YD	-	-	Yes		•	•	•	•		18
Ag + Polymer + Ni + Au	YG	Ag + Polymer + Ni + Au	YGW	Yes	•	•	•	•	•	•	36

Nickel (Ni) or Copper (Cu) barriers amplify thermal shock and are not recommended for chip sizes larger than 3030.

* Storage must be in a dry environment at a temperature of 20°C with a relative humidity below 50%, or preferably in a package enclosing a desiccant.

** Non magnetic chips series only.

SMD ENVIRONMENTAL TESTS

Ceramic chip capacitors for SMD are designed to meet test requirements of CECC 32100 and NF C 93133 standards as specified below in compliance with NF C 20700 and IEC 68 standards:

- Solderability: NF C 20758, 260°C, bath 62/36/2.
- Adherence: 5N force.
- Vibration fatigue test: NF C 20706, 20 g, 10 Hz to 2,000 Hz, 12 cycles of 20 minutes each.
- Rapid temperature change: NF C 20714, -55°C to + 125°C, 5 cycles.
- Combined climatic test: IEC 68-2-38.
- Damp heat: NF C 20703, 93 %, H.R., 40°C.
- Endurance test: 1,000 hours, 1.5 U_{RC}, 125°C.

STORAGE OF CHIP CAPACITORS

TINNED OR NON TINNED CHIP CAPACITORS

Storage must be in a dry environment at a temperature of 20°C with a relative humidity below 50 %, or preferably in a packaging enclosing a desiccant.

STORAGE IN INDUSTRIAL ENVIRONMENT:

- 2 years for tin dipped chip capacitors,
- 18 months for tin electroplated chip capacitors,
- 2 years for non tinned chip capacitors,
- 3 years for gold plated chip capacitors.

STORAGE IN CONTROLLED NEUTRAL NITROGEN ENVIRONMENT:

- 4 years for tin dipped or electroplated chip capacitors,
- 4 years for non tinned chip capacitors,
- 5 years for gold plated chip capacitors.

Storage duration should be considered from delivery date and not from batch manufacture date. The tests carried out at final acceptance stage [solderability, susceptibility to solder heat] enable to assess the compatibility to surface mounting of the chips.

User Guide

LEAD STYLES

SURFACE MOUNTING

DIL LEADS

P style



PL style

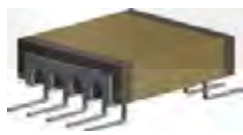

L style

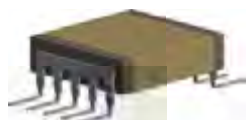

J style



RIBBON LEADS

Micro-strip (type 1)
Short Micro-strip (type 1S)



Axial (Type 2)

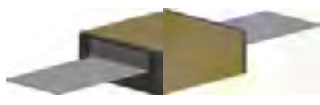

Radial (Type 3)



R style



RX style



RJ style



Please contact Exxelia sales for any lead configuration not shown.

TROUGH-HOLE MOUNTING

AXIAL AND RADIAL

Radial leads (Type 6)



Radial leads (4 leads)



Axial leads (Type 7)



DIL leads: N style

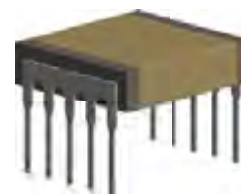

ENCAPSULATION STYLES

Ceramic encapsulation
(selfprotected)



Varnish



Conformal coating



Molding



User Guide

SOLDERING ADVICES FOR REFLOW SOLDERING

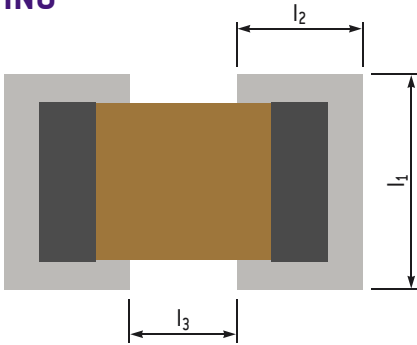

Dimensions in inches (in mm)	Reflow soldering						Wave soldering					
	l ₁		l ₂		l ₃		l ₁		l ₂		l ₃	
0402	0.043	(1.1)	0.035	(0.9)	0.012	(0.3)	0.043	(1.1)	0.047	(1.2)	0.012	(0.3)
0403	0.055	(1.4)	0.035	(0.9)	0.012	(0.3)	0.055	(1.4)	0.047	(1.2)	0.012	(0.3)
0504	0.063	(1.6)	0.051	(1.3)	0.016	(0.4)	0.063	(1.6)	0.063	(1.6)	0.016	(0.4)
0603	0.055	(1.4)	0.059	(1.5)	0.02	(0.5)	0.055	(1.4)	0.071	(1.8)	0.02	(0.5)
0805	0.073	(1.85)	0.065	(1.65)	0.024	(0.6)	0.073	(1.85)	0.077	(1.95)	0.024	(0.6)
0907	0.094	(2.4)	0.065	(1.65)	0.035	(0.9)	0.094	(2.4)	0.077	(1.95)	0.035	(0.9)
1005	0.073	(1.85)	0.067	(1.7)	0.039	(1)	0.073	(1.85)	0.079	(2)	0.039	(1)
1206	0.083	(2.1)	0.067	(1.7)	0.059	(1.5)	0.083	(2.1)	0.079	(2)	0.059	(1.5)
1210	0.118	(3)	0.069	(1.75)	0.059	(1.5)	0.118	(3)	0.081	(2.05)	0.059	(1.5)
1605	0.073	(1.85)	0.071	(1.8)	0.087	(2.2)	0.073	(1.85)	0.083	(2.1)	0.087	(2.2)
1806	0.087	(2.2)	0.073	(1.85)	0.102	(2.6)	0.087	(2.2)	0.085	(2.15)	0.102	(2.6)
1812	0.152	(3.85)	0.073	(1.85)	0.102	(2.6)	0.152	(3.85)	0.085	(2.15)	0.102	(2.6)
1825	0.281	(7.15)	0.073	(1.85)	0.102	(2.6)	0.281	(7.15)	0.085	(2.15)	0.102	(2.6)
2210	0.13	(3.3)	0.079	(2)	0.146	(3.7)	0.13	(3.3)	0.091	(2.3)	0.146	(3.7)
2220	0.228	(5.8)	0.079	(2)	0.146	(3.7)	0.228	(5.8)	0.091	(2.3)	0.146	(3.7)
2225	0.281	(7.15)	0.079	(2)	0.146	(3.7)	0.281	(7.15)	0.091	(2.3)	0.146	(3.7)

Large chips above size 2225 are not recommended to be mounted on epoxy board due to thermal expansion coefficient mismatch between ceramic capacitor and epoxy. Where larger sizes are required, it is recommended to use components with ribbon or other adapted leads so as to absorb thermo-mechanical strains.

RECOMMENDED FOOTPRINT FOR SMD CAPACITORS

Ceramic is by nature a material which is sensitive both thermally and mechanically. Stresses caused by the physical and thermal properties of the capacitors, substrates and solders are attenuated by the leads.

Wave soldering is unsuitable for sizes larger than 2220 and for the higher ends of capacitance ranges due to possible thermal shock (capacitance values given upon request).

Infrared and vapor phase reflow, are preferred for high reliability applications as inherent thermo-mechanical strains are lower than those inherent to wave soldering.

Whatever the soldering process is, it is highly recommended to apply a thermal cycle, see hereafter our recommended soldering profile:

RECOMMENDED VAPOR PHASE REFLOW PROFILE

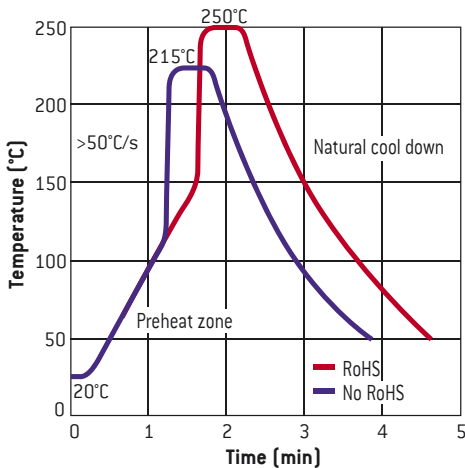

RECOMMENDED IR REFLOW PROFILE

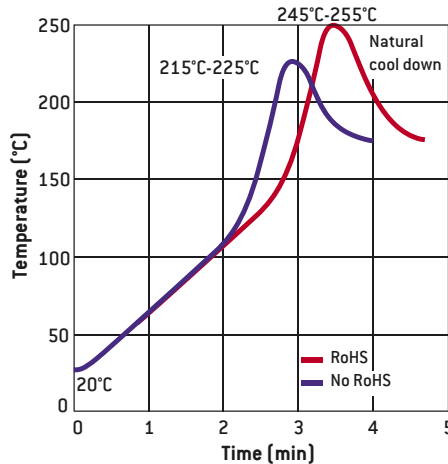

RECOMMENDED WAVE SOLDERING PROFILE

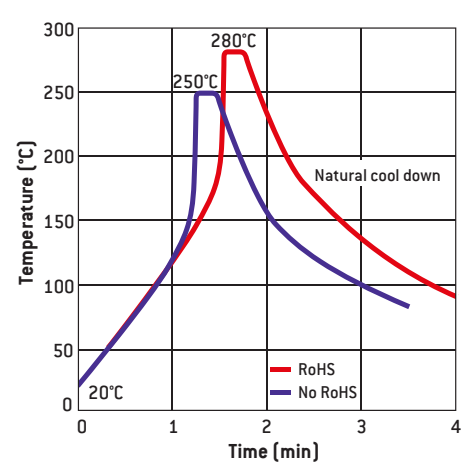

SOLDERING ADVICES FOR IRON SOLDERING

Attachment with a soldering iron is discouraged due to ceramic brittleness and the process control limitations. In the event that a soldering iron must be used, the following precautions should be observed:

- Use a substrate with chip footprints big enough to allow putting side by side one end of the capacitor and the iron tip without any contact between this tip and the component,
- place the capacitor on this footprint,

- heat the substrate until the capacitor's temperature reaches 150°C minimum (preheating step, maximum 1°C per second),
- place the hot iron tip (a flat tip is preferred) on the footprint **without touching the capacitor**. Use a regulated iron with a 30 watts maximum power. The recommended temperature of the iron is 270 ±10°C. The temperature gap between the capacitor and the iron tip must not exceed 120°C,

User Guide

- leave the tip on the footprint for a few seconds in order to increase locally the footprint's temperature,
- use a cored wire solder and put it down on the iron tip. In a preferred way use Sn/Pb/Ag 62/36/2 alloy,
- wait until the solder fillet is formed on the capacitor's termination,
- take away iron and wire solder,
- wait a few minutes so that the substrate and capacitor come back down to

the preheating temperature,

- solder the second termination using the same procedure as the first,
- let the soldered component cool down slowly to avoid any thermal shock.

PACKAGING

TAPE AND REEL

The films used on the reels correspond to standard IEC 60286-3. Films are delivered on reels in compliance with document IEC 286-3 dated 1991.

Minimum quantity is 250 chips.

Maximum quantities per reel are as follows:

- Super 8 reel - Ø 180: 2,500 chips.
- Super 8 reel - Ø 330: 10,000 chips.
- Super 12 reel - Ø 180: 1,000 chips.

Reel marking complies with CECC 32100 standard:

- Model.
- Rated capacitance.
- Capacitance tolerance.
- Rated voltage.
- Batch number.

TRAY PACKAGES

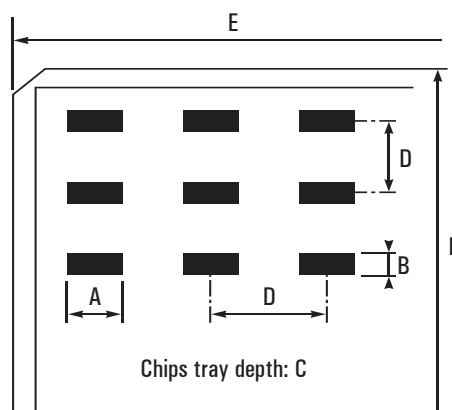

DIMENSIONAL CHARACTERISTICS OF CHIPS TRAY PACKAGES

Sizes	Nr. of chips/ package	Oriented chips	Dimensions in inches (in mm)				
			A	B	C	D	E
0402	100	No	0.0112 (0.302)		0.065 (1.65)	0.167 (4.24)	2 (50.8)
0403	100	No	0.0112 (0.302)		0.065 (1.65)	0.167 (4.24)	2 (50.8)
0504	100	Yes	0.059 (1.5)	0.045 (1.14)	0.035 (0.89)	0.167 (4.24)	2 (50.8)
0603	340	Yes	0.1 (2.54)	0.06 (1.52)	0.045 (1.14)	0.167 (4.24)	2 (50.8)
0805	100	Yes	0.1 (2.54)	0.06 (1.52)	0.045 (1.14)	0.167 (4.24)	2 (50.8)
1206	100	No	0.14 (3.56)	0.14 (3.56)	0.06 (1.52)	0.167 (4.24)	2 (50.8)
1210	100	Yes	0.14 (3.56)	0.14 (3.56)	0.06 (1.52)	0.167 (4.24)	2 (50.8)
1812	100	No	0.25 (6.35)	0.25 (6.35)	0.13 (3.3)	0.345 (8.76)	4 (101.6)
	25	Yes	0.24 (6.1)	0.265 (6.73)	0.07 (1.78)	0.345 (8.76)	2 (50.8)
2220	100	Yes	0.25 (6.35)	0.25 (6.35)	0.13 (3.3)	0.345 (8.76)	4 (101.6)
	25	Yes	0.24 (6.1)	0.265 (6.73)	0.07 (1.78)	0.345 (8.76)	2 (50.8)

HIGH Q CAPACITORS TAPE AND REEL PACKAGING SPECIFICATIONS

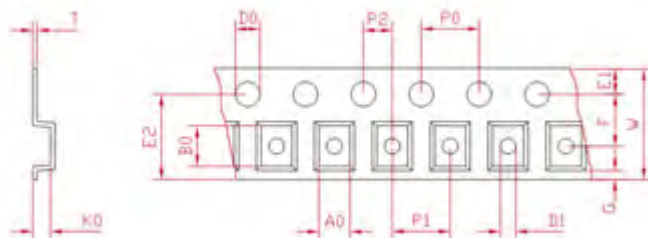

Sizes	Type (1)	W±0.3 inches (mm)	F±0.05 inches (mm)	P1±0.1 inches (mm)	T max. inches (mm)	Reel Size inches (mm)	Quantity per Reel
A (0505)	H	0,315 (8)	0,138 (3.5)	0,157 (4)	0,010 (0,25)	7,087 (180)	3'000
A (0505)	V	0,315 (8)	0,138 (3.5)	0,157 (4)	0,010 (0,25)	7,087 (180)	3'000
S (0603)	H	0,315 (8)	0,138 (3.5)	0,157 (4)	0,016 (0,4)	7,087 (180)	4'000
F (0805)	H	0,315 (8)	0,138 (3.5)	0,157 (4)	0,016 (0,4)	7,087 (180)	4'000
B (1111)	H	0,315 (8)	0,138 (3.5)	0,157 (4)	0,012 (0,3)	7,087 (180)	1'000
B (1111)	V	0,315 (8)	0,138 (3.5)	0,157 (4)	0,010 (0,25)	7,087 (180)	1'000
X (2225)	H	0,472 (12)	0,138 (5.5)	0,472 (12)	0,018 (0,45)	12,992 (330)	500
E (4040)	H	0,945 (24)	0,453±0,004 (11.5±0.1)	0,630 (16)	0,018 (0,45)	12,992 (330)	700
E (4040)	V	1,260 (32)	0,559±0,004 (14.2±0.1)	0,945 (24)	0,022 (0,55)	15 (381)	350

(1): Horizontal (H) or Vertical (V) orientation in cavities.

User Guide

EIA STANDARD CAPACITANCE VALUES

Following EIA standard, the values and multiples that are indicated in the chart below can be ordered. E48, E96 series and intermediary values are available upon request.

E6 (± 20%)	E12 (± 10%)	E24 (± 5%)
10	10	10 11 12
	12	13
	15	15 16 18
15	18	20
	22	22 24 27
	27	30
33	33	33 36 39
	39	43
	47	47 51 56
47	56	62
	68	68 75 82
	82	91

Voltage (V)	Code	Letter code
25	250	A
40	400	B
50	500	C
63	630	D
100	101	E
200	201	G
250	251	H
400	401	K
500	501	L
1,000	102	M
2,000	202	P
3,000	302	R
4,000	402	S
5,000	502	T
7,500	752	U
10,000	103	W

EIA CAPACITANCE CODE

The capacitance is expressed in three digit codes and in units of pico Farads (pF). The first and second digits are significant figures of the capacitance value and the third digit identifies the multiplier.

For capacitance value < 10pF, R designates a decimal point. See examples below:

EIA code	Capacitance value		
	in pF	in nF	in μF
2R2	2.2	0.0022	0.0000022
6R8	6.8	0.0068	0.0000068
220	22	0.022	0.000022
470	47	0.047	0.000047
181	180	0.18	0.00018
221	220	0.22	0.00022
102	1,000	1	0.001
272	2,700	2.7	0.0027
123	12,000	12	0.012
683	68,000	68	0.068
124	120,000	120	0.12
564	560,000	560	0.56
335	3,300,000	3,300	3.3
825	8,200,000	8,200	8.2
156	15,000,000	15,000	15
686	68,000,000	68,000	68
107	100,000,000	100,000	100
227	220,000,000	220,000	220

PART MARKING TOLERANCE CODES

Use the following tolerance code chart for part markings:

Tolerance	Letter code
±0.25pF	CU
±0.5pF	DU
±1pF	FU
±1%	F
±2%	G
±5%	J
±10%	K
±20%	M

PART MARKING VOLTAGE CODES

Use the following voltage code chart for part markings:

User Guide

RELIABILITY LEVELS

Exxelia proposes different reliability levels for the ceramic capacitors for both NPO and X7R ceramics.

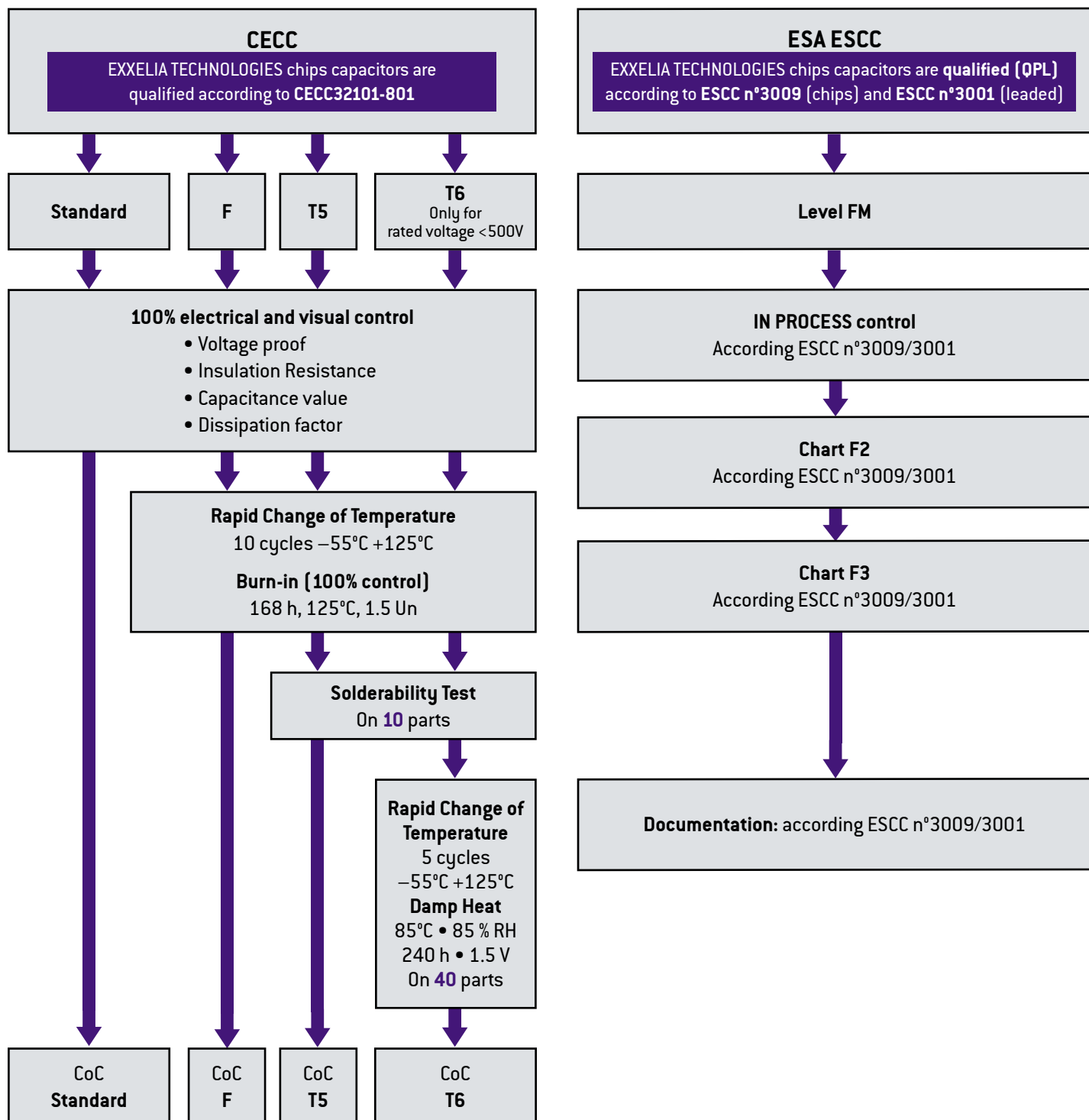

As the world's leading manufacturer of specific passive components, we stand apart through our ability to quickly evaluate the application specific engineering challenges and provide a cost-effective and efficient solutions.

For requirements that cannot be met by catalog products, we offer leading edge solutions in custom configuration: custom geometries, packaging, characteristics, all is possible thanks to our extensive experience and robust development process, while maintaining the highest level of reliability.

Where necessary, special testing is done to verify requirements, such as low dielectric absorption, ultra-high insulation resistance, low dissipation factor, stability under temperature cycling or under specified environmental conditions, etc.

HIGH CAPACITANCE

- High energy density
- Specific case sizes
- Specific shape of connections (high resistance to vibrations)

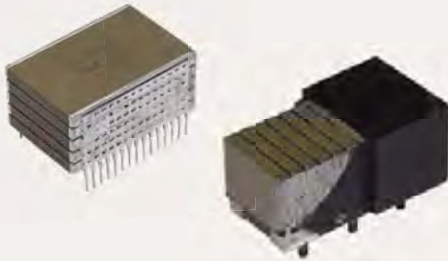

HIGH VOLTAGE

- Up to 50 kV
- Specific circular shape

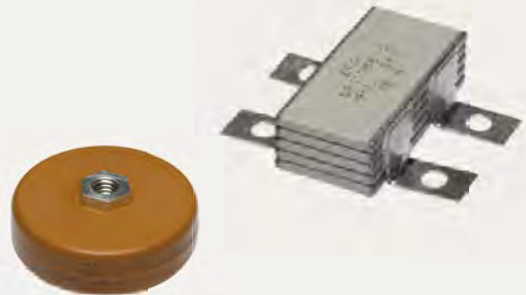

HIGH TEMPERATURE

- Up to 250°C
- Specific shape of connections
- 2,000 hours life time
- HMP soldering



OTHERS

- Screen printed resistors
- Complex components
- Full functions available

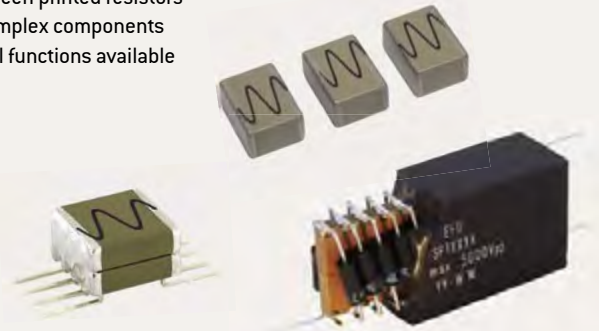

General Information

MATERIALS EXPERT

For 50 years and as a market leader, EXXELIA's comprehensive knowledge of the materials properties and performances have enabled us to design capacitors in Porcelain, NPO, BX, 2C1, BP, X7R and $-2200\text{ppm}/^\circ\text{C}$ ceramics.

CUSTOM DESIGNS

Our catalog products don't meet your application?

Based on the valuable experience accumulated over the design of 2,000+ specific ceramic capacitors, you can trust EXXELIA to define a qualitative custom solution in a time effective manner.

NO OBSOLESCENCE

Choosing a standard or custom EXXELIA product means you won't have to worry about obsolescence.

TYPICAL APPLICATIONS

- Aerospace & Defense: cockpit panels, flight control, radio systems, missile guidance systems...
- Space: military and commercial satellites, launcher...
- Medical: MRI, external defibrillators, implantable devices...
- Telecommunications: base stations...
- Oil and gas: drilling tools, MWD, LWD, wellheads...

ISO 9001 AND AS9100C

Quality is at the core of Exxelia's corporate culture. Each sites has its own certifications.

CERTIFICATIONS

Capacitors manufactured by EXXELIA comply with American and European standards and meet the requirements of many international standards. For Space qualified parts (ESA QPL), please refer to our catalog «Ceramic capacitors for Space applications».

QUALITY & RELIABILITY

EXXELIA is committed to design and manufacture high quality and reliability products. The test cycles reproducing the most adverse operating conditions over extended periods (up to 10 000 hours) have logged to date well over 5.10^9 hours/ $^\circ\text{C}$ Component.

Failure rate data can be provided upon request.

CONFLICT MINERALS

EXXELIA is committed to an approach based on «Conflict Minerals Compliance». This US SEC rule demands complete traceability and a control mechanism for the mineral procurement chain, encouraging importers to buy only «certified» ore.

We have discontinued relations with suppliers that procure from the Democratic Republic of the Congo or an adjoining country.

ENVIRONMENT

EXXELIA is committed to applying a robust environmental policy, from product design through to shipment. To control its environmental footprint and reconcile this with the company's functional imperatives, our environmental policy provides for the reduction or elimination of hazardous substances. We also focus on compliance with European Union directives and regulations, notably REACH and RoHS.

RoHS COMPLIANCY

SMD CAPACITORS

The capacitor terminations are generally protected by a nickel barrier formed by electrolytic deposit. This barrier gives chip capacitors leaching performance far exceeding the requirements of all applicable standards. The nickel barrier guarantees a minimum resistance to soldering heat for a period of 1 minute at 260°C in a tin-lead (60/40) or tin-lead-silver (62/36/2) bath without noticeable alteration to the solderability. It also allows repeated soldering-unsoldering and the longer soldering times required by reflow techniques.

However nickel barrier amplifies thermal shock and is not recommended for chip sizes equal or greater than CNC Y (30 30) - [C 282 to C 288 - CNC 80 to CNC 94].

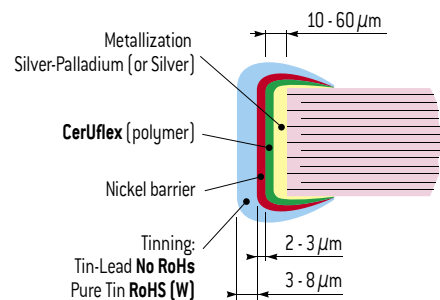

LEADED COMPONENTS

As well as for SMD products, leaded capacitors ranges can also be RoHS. These products, which are characterized by the suffix «W» added to the commercial type, are naturally compatible with the soldering alloys used in RoHS mounting technology. The connections coating is generally an alloy SnAg (with a maximum of 4% Ag). However, on a few products that EXXELIA will precise on request, the coating is pure silver.