

# TCE / TCX / TCN / TXR Molded Series

## Radial Molded Capacitors

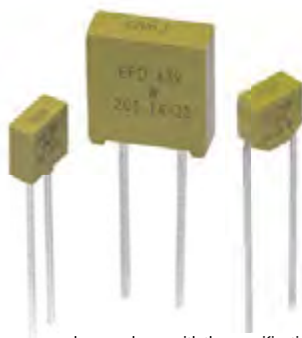

In accordance with the specifications of CECC 30700 and NF C 83132 standards

### FEATURES

- Radial molded capacitors
- NPO, BX, 2C1, X7R dielectrics
- Capacitance range: 0.5pF to 4.7μF
- RoHS and Non RoHS compliant capacitors available

### PHYSICAL CHARACTERISTICS

#### CONSTRUCTION

Leaded MLCC capacitors for through-hole mounting:  
Epoxy molded capacitors

#### MARKING

Capacitance, tolerance, voltage, dielectric, date code.

### TCN 50/60 R : Enhanced reliability types of TCN 50 A and TCN 60 A.

### ELECTRICAL SPECIFICATIONS

Description	NPO	BX	2C1	X7R
Dielectric code	CE	CX	CN	XR
Operating temperature	-55°C to +125°C			
Climatic category	55 / 125 / 56			
Rated voltage (U <sub>RC</sub> )	25V <sub>DC</sub> to 500V <sub>DC</sub>			
Max. ΔC/°C over temperature range without DC voltage applied	NA	±15%	±20%	±15%
Maximum ΔC/°C over temperature range with rated voltage applied	NA	+15% -25%	+20% -30%	NA
Temperature coefficient with or without DC voltage applied	(0±30)ppm/°C	NA	NA	NA
Dielectric withstanding voltage	2.5 U <sub>RC</sub>			
Capacitance	at 1MHz for C ≤ 1,000pF at 1kHz for C > 1,000pF		at 1MHz for C ≤ 100pF at 1kHz for C > 100pF	
Dissipation factor at 25°C	≤ 0.015 (150/C + 7)% at 1MHz for C ≤ 50pF ≤ 0.15% at 1MHz for 50pF < C ≤ 1,000pF ≤ 0.15% at 1kHz for C > 1,000pF		≤ 2.5% at 1MHz for C ≤ 100pF ≤ 2.5% at 1kHz for C > 100pF	
Insulation resistance at 25°C	≥ 100,000 MΩ for C ≤ 10nF ≥ 1,000 MΩ.μF for C > 10nF			
Aging	None		≤ 2.5% per decade hour	

### HOW TO ORDER

T	CE	61	A	W	F	6.8nF	10%	25V	B	-
Series	Dielectric	Size	Bismuth	RoHS compliant	Quality level	Capacitance	Tolerance	Rated voltage	Packaging	Reliability level
T = Radial leaded, molded capacitor	CE = NPO CX = BX CN = 2C1 XR = X7R	50 60 61 61N 62 62N 63 64	-- For all models  A = Bismuth free for 50/60 sizes only (tg δ at -55°C ≤ 350.10 <sup>-4</sup> )	-- No RoHS  W = RoHS compliant	-- standard quality level  F = Hi-Rel quality: screening in accordance with Exxelia specification	Capacitance value in clear	NPO: cap. value ≤ 12pF ±0.25pF cap. value ≤ 8.2pF ±0.5pF ±1pF cap. value > 22pF ±1% cap. value > 12pF ±2% cap. value > 8.2pF ±5% ±10% cap. value > 3.9pF ±20%  Available for BX, 2C1 and X7R: ±5% ±10% ±20%	25V 50V 100V 200V 500V  Intermediary and higher voltages available on request.	-- Exxelia packaging Available for quantity ≥ 500: B = reel	For F parts only. Acc. to Exxelia spec. - T5 T6 See page 15

Radial Molded Capacitors

# TCE / TCX / TCN / TXR Molded Series

## DIMENSIONS in inches (mm)

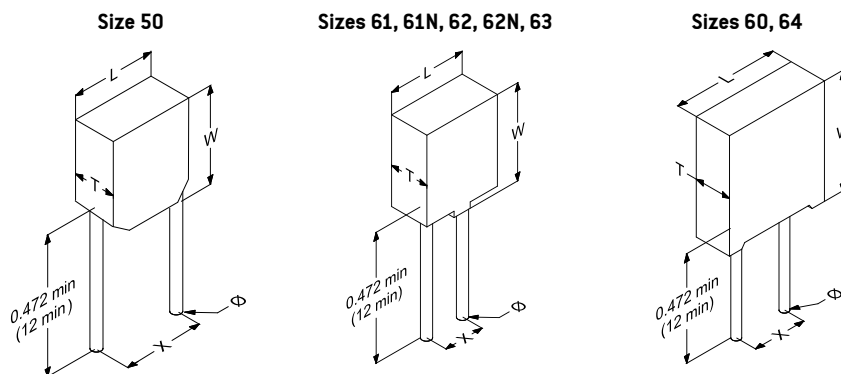

## STANDARD RATINGS

Size	61				61N				62				62N				63				64												
Dimensions inches (mm)	L	0.138 ± 0.02 (3.5 ± 0.5)								0.197 ± 0.02 (5 ± 0.5)								0.295 ± 0.02 (7.5 ± 0.5)								0.394 ± 0.02 (10 ± 0.5)							
	W	0.178 max (4.5 max)								0.237 max (6 max)								0.335 max (8.5 max)								0.434 max (11 max)							
	T	0.098 ± 0.008 (2.5 ± 0.2)								0.098 (2.5 ± 0.2)								0.098 (2.5 ± 0.2)								0.138 (3.5)							
	X	0.1 ± 0.008 (2.54 ± 0.2)				0.2 ± 0.008 (5.08 ± 0.2)				0.1 ± 0.008 (2.54 ± 0.2)				0.2 ± 0.008 (5.08 ± 0.2)				0.2 ± 0.008 (5.08 ± 0.2)				0.2 ± 0.008 (5.08 ± 0.2)											
	Ø ± 10%	0.024 (0.6)								0.024 (0.6)								0.024 (0.6)								0.031 (0.8)							
Dielectric	NPO	BX	2C1	X7R	NPO	BX	2C1	X7R	NPO	BX	2C1	X7R	NPO	BX	2C1	X7R	NPO	BX	2C1	X7R													
Dielectric code	CE	CX	CN	XR	CE	CX	CN	XR	CE	CX	CN	XR	CE	CX	CN	XR	CE	CX	CN	XR													
Min. Cap. value	1pF				27pF				1pF				33pF				4.7pF				330pF				220pF				4.7nF				
Rated voltage (U <sub>RC</sub> )	25V	6.8nF	220nF	220nF	220nF	33nF	820nF	1µF	1µF	68nF	1.8µF	1.8µF	1.8µF	180nF	4.7µF	4.7µF	4.7µF																
	50V	3.3nF	56nF	82nF	100nF	15nF	220nF	390nF	470nF	47nF	1µF	1.2µF	1.2µF	120nF	2.7µF	3.9µF	3.9µF																
	63V	2.7nF	33nF	47nF	68nF	12nF	150nF	220nF	330nF	39nF	560nF	1µF	1µF	100nF	1.8µF	2.7µF	2.7µF																
	100V	1.5nF	12nF	22nF	39nF	6.8nF	56nF	120nF	180nF	18nF	220nF	470nF	680nF	56nF	680nF	1.2µF	1.8µF																
	200V	390pF	3.3nF	5.6nF	10nF	1.8nF	15nF	27nF	47nF	6.8nF	56nF	100nF	180nF	22nF	180nF	330nF	560nF																
	250V	270pF	1.8nF	3.9nF	6.8nF	1.2nF	8.2nF	18nF	27nF	4.7nF	33nF	68nF	120nF	15nF	100nF	220nF	330nF																
	500V	100pF	-	560pF	1.2nF	470pF	-	3.3nF	4.7nF	2.2nF	-	10nF	22nF	6.8nF	-	47nF	82nF																

Size	50				60												
Dimensions inches (mm)	L	0.197 ± 0.02 (5 ± 0.5)								0.295 ± 0.02 (7.5 ± 0.5)							
	W	0.197 ± 0.008 (5 ± 0.2)								0.295 ± 0.008 (7.5 ± 0.2)							
	T	0.098 max. (2.5 max.)								0.098 max. (2.5 max.)							
	X	0.2 ± 0.008 (5.08 ± 0.2)				0.2 ± 0.008 (5.08 ± 0.2)											
	Ø ± 10%	0.024 (0.6)								0.024 (0.6)							
Dielectric	NPO		BX		2C1		X7R		NPO		BX		2C1		X7R		
Dielectric code	CE		CX		CN		XR		CE		CX		CN		XR		
Min. Cap. value	1pF		10pF		10pF		10pF		4.7pF		330pF		330pF		330pF		
Rated voltage (U <sub>RC</sub> )	25V	27nF	820nF	820nF	820nF	56nF	1.5µF	1.5µF	1.5µF								
	50V	12nF	220nF	270nF	390nF	39nF	1µF	1µF	1µF								
	63V	10nF	120nF	180nF	270nF	27nF	470nF	1µF	820nF								
	100V	5.6nF	47nF	100nF	150nF	15nF	180nF	390nF	560nF								
	200V	1.5nF	12nF	22nF	39nF	5.6nF	39nF	82nF	150nF								
	250V	1.2nF	6.8nF	15nF	27nF	3.9nF	27nF	56nF	100nF								
	500V	390pF	-	1.8nF	4.7nF	1.5nF	-	8.2nF	15nF								

Available capacitance values:

NPO: E6, E12, E24, E48, E96 (see page 14). Specific values upon request.

X7R: E6, E12, E24 (see page 14). Specific values upon request.

The above table defines the standard products, other components may be built upon request.

STANDARD

# General Information NPO/COG (Class 1)

## COMPOSITION

NPO capacitors are produced by using a dielectric made of titanium dioxide ( $TiO_2$ ) modified by magnesium oxide  $MgO$  (white ceramics) or a rare earth oxide, e.g.  $Nd_2O_3$  (other NPO ceramics).

As a consequence, these ceramics are non ferro-electric materials with a low dielectric constant ( $\epsilon_r \leq 110$ ).

Other additives are used to dope the dielectric constant up to 300. Though derogating from CG class, doped dielectric constant features a linear temperature drift and a matchless stability compared with class 2 ceramics.

The wide range of possible NPO dielectric compositions enables to use the material best suited to the application :

- standard applications,
- high voltage,
- high temperature,
- microwave,
- power capacitors.

«Temperature coefficient» compositions are particularly suitable for impedance matching. These ceramics usually enable to achieve temperature coefficients from 0 to  $-1\,000$  ppm/°C. For specific requirements, other coefficients can be achieved (e.g.  $-3\,300$  ppm/°C).

## STABILITY

As  $\epsilon_r$  is low, these dielectrics are extremely stable with only minor changes under such stresses as :

- temperature,
- voltage,
- frequency.

In addition, they are not affected by piezo-electric phenomena and their dielectric absorption coefficients are low and even non measurable for dielectrics with the lowest constants.

## MECHANICAL PROPERTIES

Class 1 ceramics are the perfect match for metallic electrodes made of Pd or Ag-Pd alloy and have a high hardness and mechanical toughness making them resistant to thermal shocks (wave soldering for instance) and to thermal cycling after mounting on substrates having an expansion coefficient close to the capacitor one.

Ceramic chips meet CECC 32100 and NF C 93133 standards.

## CLIMATIC CATEGORIES

Climatic categories are identified by three-digit codes as per NF C 20700 standard. Coding method is described in table 6.

e.g. :  $-55^\circ C + 125^\circ C / 56$  days category is identified by code 434.

## TEMPERATURE COEFFICIENT

Temperature coefficient $k\theta$ (ppm/°C)		
$k\theta$	Tolerances	Code letter
+ 100	$\pm 30$	AG
0	$\pm 30$	CG
- 33	$\pm 30$	HG
- 75	$\pm 30$	LG
- 150	$\pm 30$	PG
- 220	$\pm 30$	RG
- 330	$\pm 60$	SH
- 470	$\pm 60$	TH
- 750	$\pm 120$	UJ
- 1 000	$\pm 250$	QK

# General Information NPO/COG (Class 1)

IMPEDANCE VERSUS FREQUENCY

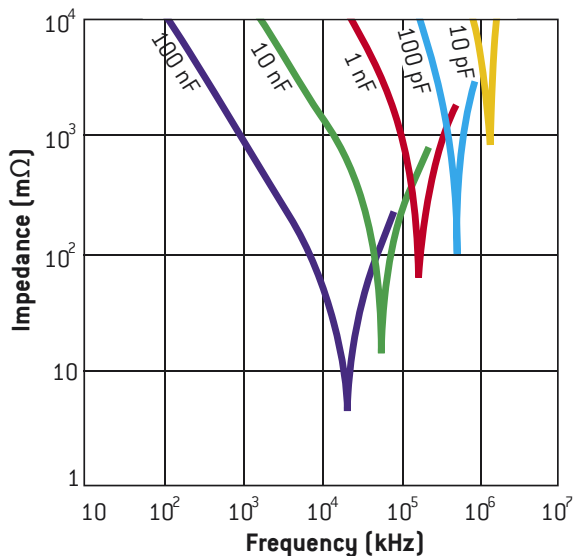

DISSIPATION FACTOR VERSUS FREQUENCY

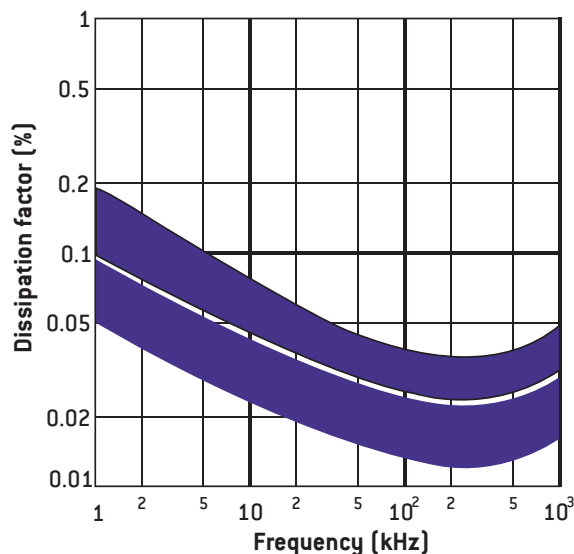

CAPACITANCE CHANGE VERSUS TEMPERATURE

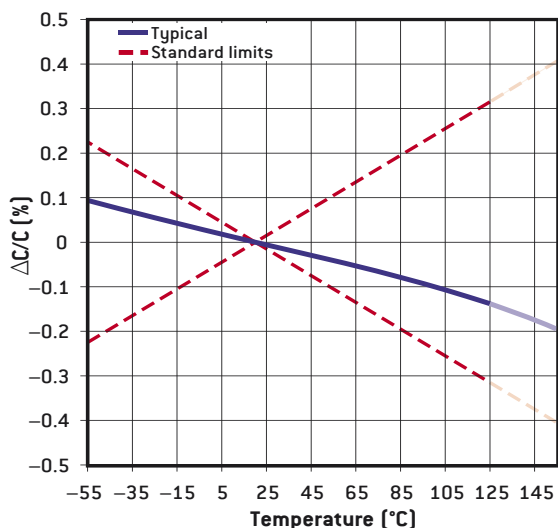

IR VERSUS TEMPERATURE

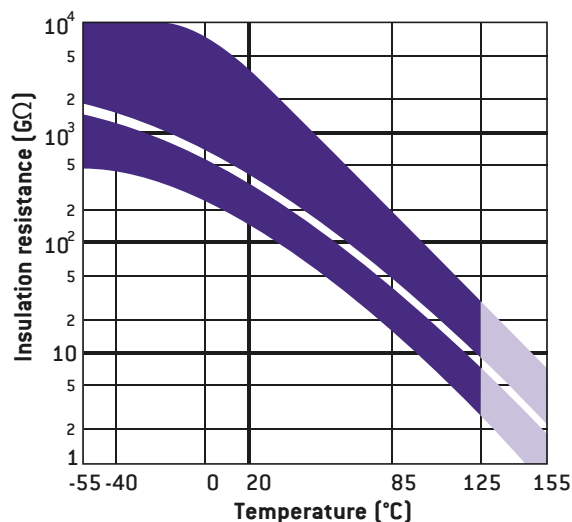

DISSIPATION FACTOR VERSUS TEMPERATURE

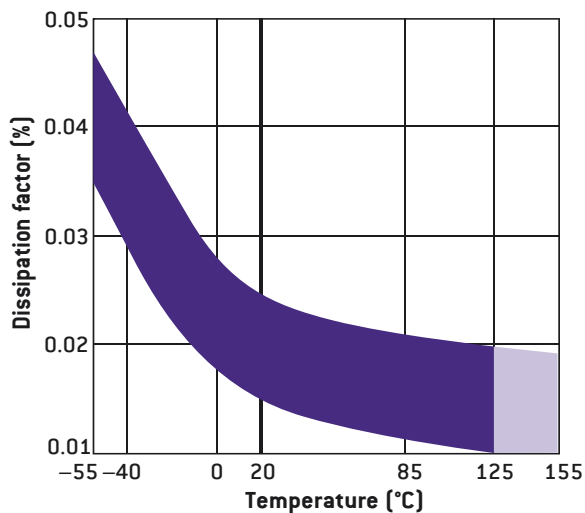

TYPICAL FAILURE RATE VERSUS TEMPERATURE

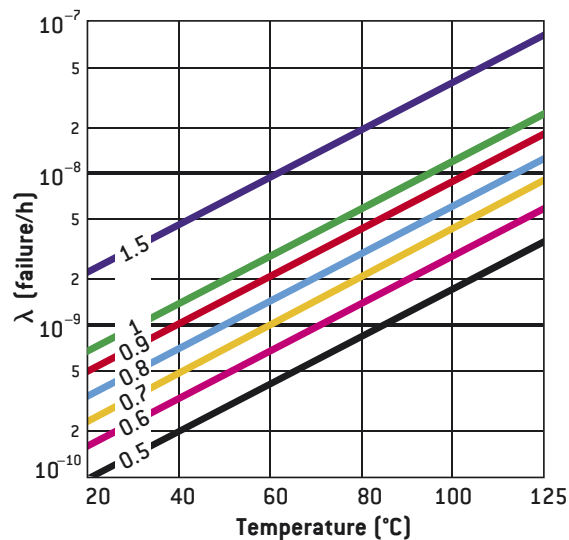

STANDARD

# General Information X7R (Class 2)

## COMPOSITION

Class 2 capacitors are produced by using a dielectric made of barium titanate ( $\text{Ba Ti O}_3$ ). By nature, the dielectric is a ferroelectric compound with a high dielectric constant usually varying :

- from 1 000 to 5 000 - typical of capacitors meeting 2C1 type specifications (BX, X7R),
- from 5 000 to 15 000 - typical of capacitors meeting Z5U or Y5V type specifications.

Depending on whether the dielectric contains a flux additive, mainly bismuth or boron, electrodes are made of Ag-Pd alloys with high silver content or high palladium content, even pure palladium in some cases.

## STABILITY

As the dielectric is a ferro-electric material, class 2 capacitors present significant variations under such stresses as :

- temperature,
- voltage,
- frequency.

In addition, the dielectric absorption coefficient can reach a few % and piezo-electric phenomena can affect the dielectric at critical frequencies (full information and specific documents available on request).

## MECHANICAL PROPERTIES

Class 2 dielectrics are hard materials and are sensitive to thermo-mechanical stress. Stress should be limited when mounting and adequate substrates with an adapted expansion coefficient used.

## BISMUTH OR BISMUTH FREE DIELECTRICS

Class 2 capacitors are made of ceramics capable to embed a flux element (e.g. bismuth or boron salt). Their eventual use will affect the choice of electrode alloys firing temperature used. Capacitor behavior under such constraints as temperature, voltage, frequency and even reliability, in some applications (further information available on request), is also different.

That is why French and European standard authorities have decided to differentiate bismuth from bismuth free ceramics by measuring tangent  $\delta$  at  $-55^\circ\text{C}$ . Tangent  $\text{Tg } \delta (-55^\circ\text{C})$   $350.10^{-4}$  in flux free dielectrics.

Flux free dielectrics are identified by suffix «A» after capacitor type (e.g. CNC2A).

## CAPACITANCE/TEMPERATURE RELATIONSHIP

Capacitance variations are defined within a specified temperature range,  $+20^\circ\text{C}$  being the reference temperature. This characteristic is expressed by associating the temperature range and capacitance stability.

Stability category Code letter	Max. capacitance variation (%) with reference to capacitance at $20^\circ\text{C}$	
	Without voltage	At rated DC voltage ( $U_{\text{DC}}$ )
B	$\pm 10$	+ 10 – 15
C	$\pm 20$	+ 20 – 30
D	+ 20 – 30	+ 20 – 40
E	+ 20 – 55	+ 20 – 65
R	+ 15 – 15	Not applicable
X	+ 15 – 15	+ 15 – 25

Temperature category	
Code	Temperature range
1	$-55^\circ\text{C} + 125^\circ\text{C}$
2	$-55^\circ\text{C} + 85^\circ\text{C}$
4	$-25^\circ\text{C} + 85^\circ\text{C}$

CAPACITANCE CHANGE VERSUS FREQUENCY

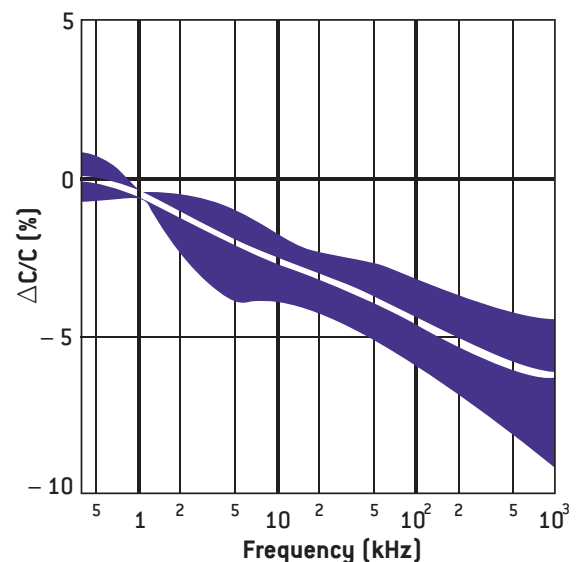

# General Information X7R (Class 2)

STANDARD

IMPEDANCE VERSUS FREQUENCY

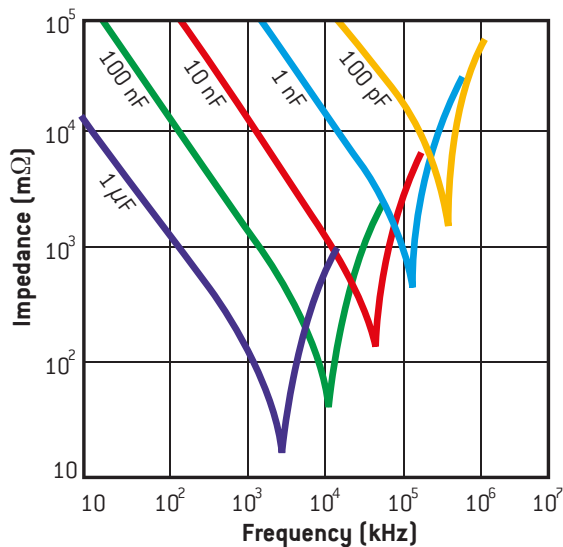

DISSIPATION FACTOR VERSUS FREQUENCY

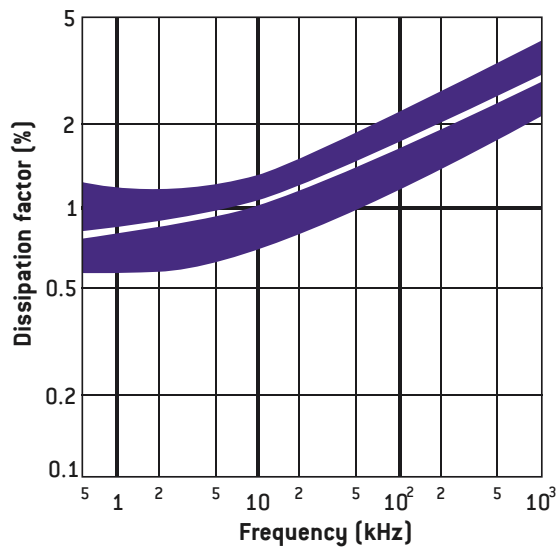

DISSIPATION FACTOR VERSUS TEMPERATURE

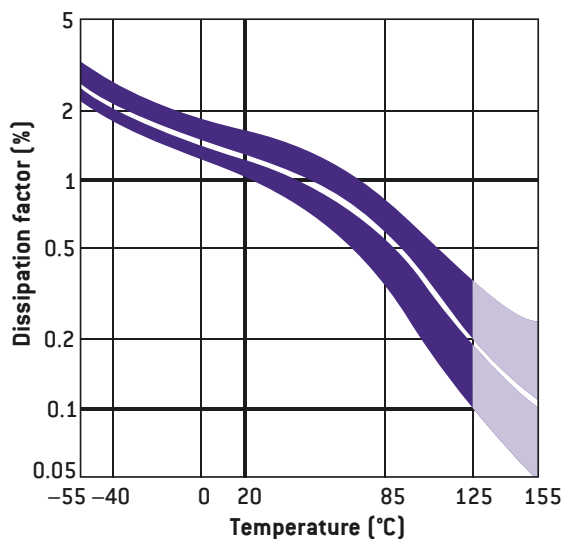

CAPACITANCE CHANGE VERSUS TEMPERATURE

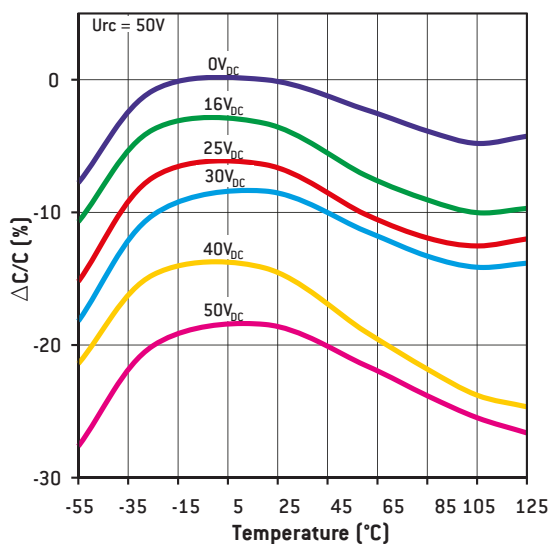

IR VERSUS TEMPERATURE

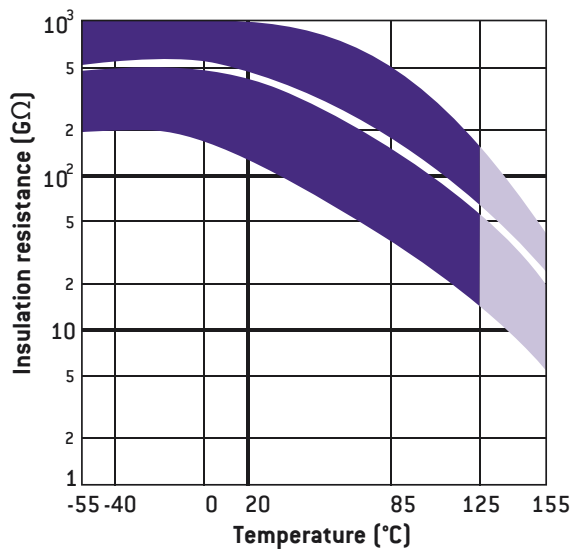

TYPICAL FAILURE RATE VERSUS TEMPERATURE

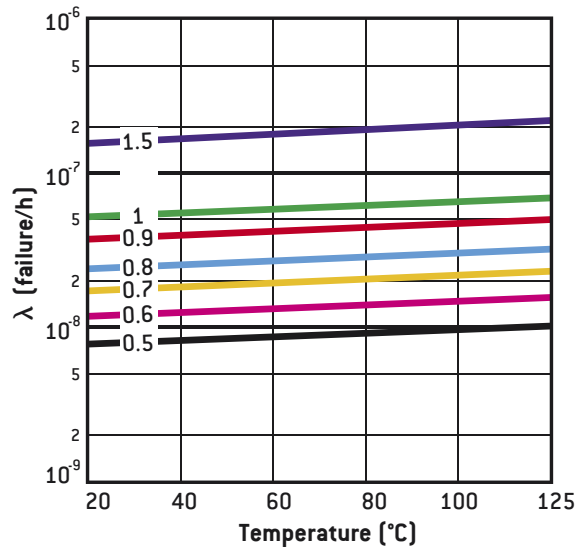

# Ceramic Capacitors Technology

## MLCC STRUCTURE

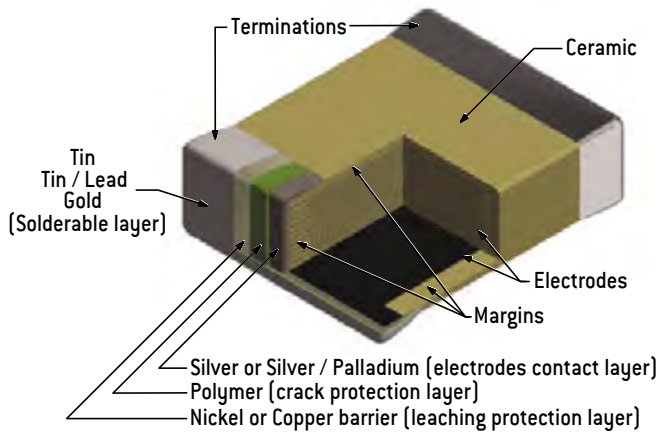

## EQUIVALENT CIRCUIT

Capacitor is a complex component combining resistive, inductive and capacitive phenomena. A simplified schematic for the equivalent circuit is:

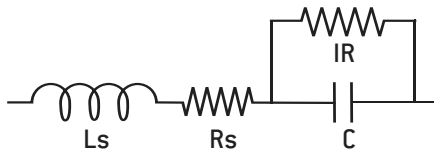

## DIELECTRIC CHARACTERISTICS

**Insulation Resistance (IR)** is the resistance measured under DC voltage across the terminals of the capacitor and consists principally of the parallel resistance shown in the equivalent circuit. As capacitance values and hence the area of dielectric increases, the IR decreases and hence the product  $[C \times IR]$  is often specified in  $\Omega \cdot F$  or  $M\Omega \cdot \mu F$ .

**The Equivalent Series Resistance (ESR)** is the sum of the resistive terms which generate heating when capacitor is used under AC voltage at a given frequency  $(f)$ .

**Dissipation factor (DF)** is the ration of the apparent power input will turn to heat in the capacitor:

$$DF = 2\pi f C ESR$$

When a capacitor works under AC voltage, **heat power loss (P)**, expressed in Watt, is equal to:

$$P = 2\pi f C V_{rms}^2 DF$$

**The series inductance (Ls)** is due to the currents running through the electrodes. It can distort the operation of the capacitor at high frequency where the **impedance (Z)** is given as:

$$Z = R_s + j [L_s \cdot \omega - 1/(C \cdot \omega)] \text{ with } \omega = 2\pi f$$

When frequency rises, the capacitive component of capacitors is gradually canceled up to the resonance frequency, where :

$$Z = R_s \text{ and } L_s C \cdot \omega^2 = 1$$

Above this frequency the capacitor behaves like an inductor.

	P100	NPO	N2200 (C4xx)	BX	2C1	X7R
<b>Dielectric material</b>	Porcelain	Magnesium titanate or Neodymium baryum titanate	Barium zirconate titanate	Baryum titanate (BaTiO <sub>3</sub> )		
<b>Dielectric constant</b>	15 – 18	20 – 85	450	2,000 – 5,000		
<b>Electrode technology</b>	PME (Precious Metal Electrodes): Ag/Pd					
<b>Capacitance variation between –55°C and +125°C without DC voltage</b>	[100±30]ppm/°C	[0±30]ppm/°C	[–2,200±500] ppm/°C	±15%	±20%	±15%
<b>Capacitance variation between –55°C and +125°C with DC rated voltage</b>			0-15%	15%–25%	20%–30%	Not applicable
<b>Piezo-electric effect</b>	None		None	Yes		
<b>Dielectric absorption</b>	None		Few %	Few %		
<b>Thermal shock sensitive</b>	+		+	++		

# Ceramic Capacitors Technology

## MANUFACTURING STEPS

SLIP CASTING



A slurry, a mix of ceramic powder, binder and solvents, is poured onto conveyor belt inside a drying oven, resulting in a dry ceramic sheet.

ELECTRODE SCREEN PRINTING

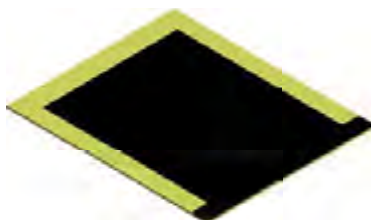

The electrode ink, made from a metal powder mixed with solvents, is printed onto the ceramic sheets using a screen printing process.

STACKING

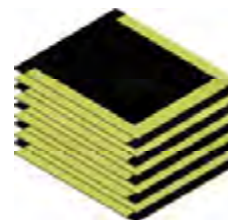

The sheets with electrode printed are stacked to create a multilayer structure.

TERMINATIONS

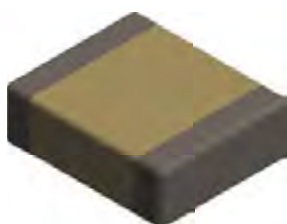

Each terminal of the capacitor is dipped in the termination ink, mix of metal powder, solvents and glass frit and the parts are fired in an oven.

SINTERING

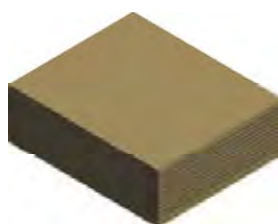

The parts are sintered in an oven with a precise temperature profile which is very important to the characteristics of the capacitors.

PRESSING

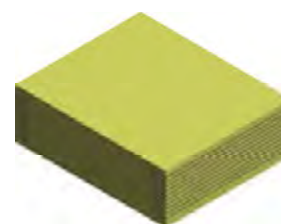

Pressure is applied to the stack to fuse all the separate layers, this created a monolithic structure.

TERMINATIONS PLATING

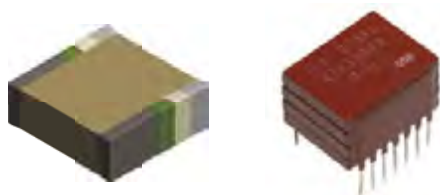

Stacking + leads soldering + encapsulation  
[see pages 10-11]

FINAL TESTING

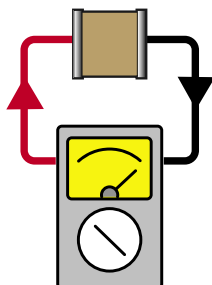

PACKAGING





# User Guide

## SMD TERMINATIONS

NON RoHS COMPLIANT	Code	RoHS COMPLIANT	Code	Recommended mounting process							Storage (months)*
				Magnetic	Epoxy bonding	Iron soldering	Wave soldering	Vapor phase soldering	Infrared soldering	Wire bonding	
Ag	Q	Ag	QW / P	No	•	•	•	•			18
Ag/Pd/Pt	-	Ag/Pd/Pt	W / A	No	•	•	•				24
Ag/Pd/Pt + dipped Sn/Pb 60/40	H	Ag/Pd/Pt + dipped Sn	HW	No		•					24
Ag + Ni + electrolytic Sn/Pb 95/5	C	Ag + Ni + electrolytic Sn	CW / S	Yes		•	•	•	•		18
Ag + Ni + electrolytic Sn/Pb 60/40	D	-	-	Yes		•	•	•	•		18
-	-	Ag + Cu + electrolytic Sn	C**	No		•	•	•	•		18
Ag + Ni + dipped Sn/Pb 60/40	E	-	-	Yes		•	•				24
Ag + Ni + Au	G	Ag + Ni + Au	GW	Yes	•	•	•	•	•	•	36
Ag + Polymer + Ni + Sn/Pb 95/5	YC	Ag + Polymer + Ni + Sn	YCW	Yes		•	•	•	•		18
Ag + Polymer + Ni + Sn/Pb 60/40	YD	-	-	Yes		•	•	•	•		18
Ag + Polymer + Ni + Au	YG	Ag + Polymer + Ni + Au	YGW	Yes	•	•	•	•	•	•	36

Nickel (Ni) or Copper (Cu) barriers amplify thermal shock and are not recommended for chip sizes larger than 3030.

\* Storage must be in a dry environment at a temperature of 20°C with a relative humidity below 50%, or preferably in a package enclosing a desiccant.

\*\* Non magnetic chips series only.

## SMD ENVIRONMENTAL TESTS

Ceramic chip capacitors for SMD are designed to meet test requirements of **CECC 32100** and **NF C 93133** standards as specified below in compliance with **NF C 20700** and **IEC 68** standards:

- Solderability: **NF C 20758**, 260°C, bath 62/36/2.
- Adherence: 5N force.
- Vibration fatigue test: **NF C 20706**, 20 g, 10 Hz to 2,000 Hz, 12 cycles of 20 minutes each.
- Rapid temperature change: **NF C 20714**, -55°C to + 125°C, 5 cycles.
- Combined climatic test: **IEC 68-2-38**.
- Damp heat: **NF C 20703**, 93 %, H.R., 40°C.
- Endurance test: 1,000 hours, 1.5 U<sub>RC</sub>, 125°C.

## STORAGE OF CHIP CAPACITORS

### TINNED OR NON TINNED CHIP CAPACITORS

Storage must be in a dry environment at a temperature of 20°C with a relative humidity below 50 %, or preferably in a packaging enclosing a desiccant.

### STORAGE IN INDUSTRIAL ENVIRONMENT:

- 2 years for tin dipped chip capacitors,
- 18 months for tin electroplated chip capacitors,
- 2 years for non tinned chip capacitors,
- 3 years for gold plated chip capacitors.

### STORAGE IN CONTROLLED NEUTRAL NITROGEN ENVIRONMENT:

- 4 years for tin dipped or electroplated chip capacitors,
- 4 years for non tinned chip capacitors,
- 5 years for gold plated chip capacitors.

Storage duration should be considered from delivery date and not from batch manufacture date. The tests carried out at final acceptance stage [solderability, susceptibility to solder heat] enable to assess the compatibility to surface mounting of the chips.

# User Guide

## LEAD STYLES

### SURFACE MOUNTING

#### DIL LEADS

P style



PL style

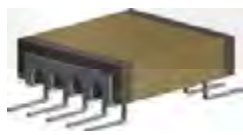

L style

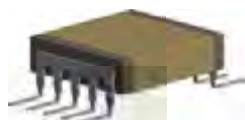

J style



#### RIBBON LEADS

Micro-strip (type 1)  
Short Micro-strip (type 1S)



Axial (Type 2)

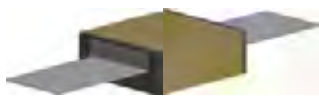

Radial (Type 3)



R style



RX style



RJ style



Please contact Exxelia sales for any lead configuration not shown.

### TROUGH-HOLE MOUNTING

#### AXIAL AND RADIAL

Radial leads (Type 6)



Radial leads (4 leads)



Axial leads (Type 7)



DIL leads: N style



### ENCAPSULATION STYLES

Ceramic encapsulation  
(selfprotected)



Varnish



Conformal coating



Molding



# User Guide

## SOLDERING ADVICES FOR REFLOW SOLDERING

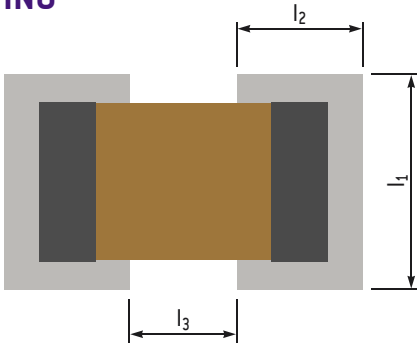

Large chips above size 2225 are not recommended to be mounted on epoxy board due to thermal expansion coefficient mismatch between ceramic capacitor and epoxy. Where larger sizes are required, it is recommended to use components with ribbon or other adapted leads so as to absorb thermo-mechanical strains.

Dimensions in inches (in mm)	Reflow soldering						Wave soldering					
	l <sub>1</sub>		l <sub>2</sub>		l <sub>3</sub>		l <sub>1</sub>		l <sub>2</sub>		l <sub>3</sub>	
0402	0.043	(1.1)	0.035	(0.9)	0.012	(0.3)	0.043	(1.1)	0.047	(1.2)	0.012	(0.3)
0403	0.055	(1.4)	0.035	(0.9)	0.012	(0.3)	0.055	(1.4)	0.047	(1.2)	0.012	(0.3)
0504	0.063	(1.6)	0.051	(1.3)	0.016	(0.4)	0.063	(1.6)	0.063	(1.6)	0.016	(0.4)
0603	0.055	(1.4)	0.059	(1.5)	0.02	(0.5)	0.055	(1.4)	0.071	(1.8)	0.02	(0.5)
0805	0.073	(1.85)	0.065	(1.65)	0.024	(0.6)	0.073	(1.85)	0.077	(1.95)	0.024	(0.6)
0907	0.094	(2.4)	0.065	(1.65)	0.035	(0.9)	0.094	(2.4)	0.077	(1.95)	0.035	(0.9)
1005	0.073	(1.85)	0.067	(1.7)	0.039	(1)	0.073	(1.85)	0.079	(2)	0.039	(1)
1206	0.083	(2.1)	0.067	(1.7)	0.059	(1.5)	0.083	(2.1)	0.079	(2)	0.059	(1.5)
1210	0.118	(3)	0.069	(1.75)	0.059	(1.5)	0.118	(3)	0.081	(2.05)	0.059	(1.5)
1605	0.073	(1.85)	0.071	(1.8)	0.087	(2.2)	0.073	(1.85)	0.083	(2.1)	0.087	(2.2)
1806	0.087	(2.2)	0.073	(1.85)	0.102	(2.6)	0.087	(2.2)	0.085	(2.15)	0.102	(2.6)
1812	0.152	(3.85)	0.073	(1.85)	0.102	(2.6)	0.152	(3.85)	0.085	(2.15)	0.102	(2.6)
1825	0.281	(7.15)	0.073	(1.85)	0.102	(2.6)	0.281	(7.15)	0.085	(2.15)	0.102	(2.6)
2210	0.13	(3.3)	0.079	(2)	0.146	(3.7)	0.13	(3.3)	0.091	(2.3)	0.146	(3.7)
2220	0.228	(5.8)	0.079	(2)	0.146	(3.7)	0.228	(5.8)	0.091	(2.3)	0.146	(3.7)
2225	0.281	(7.15)	0.079	(2)	0.146	(3.7)	0.281	(7.15)	0.091	(2.3)	0.146	(3.7)

### RECOMMENDED FOOTPRINT FOR SMD CAPACITORS

Ceramic is by nature a material which is sensitive both thermally and mechanically. Stresses caused by the physical and thermal properties of the capacitors, substrates and solders are attenuated by the leads.

Wave soldering is unsuitable for sizes larger than 2220 and for the higher ends of capacitance ranges due to possible thermal shock (capacitance values given upon request).

Infrared and vapor phase reflow, are preferred for high reliability applications as inherent thermo-mechanical strains are lower than those inherent to wave soldering.

Whatever the soldering process is, it is highly recommended to apply a thermal cycle, see hereafter our recommended soldering profile:

### RECOMMENDED VAPOR PHASE REFLOW PROFILE

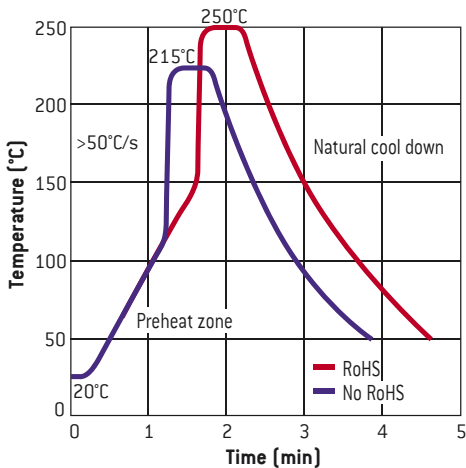

### RECOMMENDED IR REFLOW PROFILE

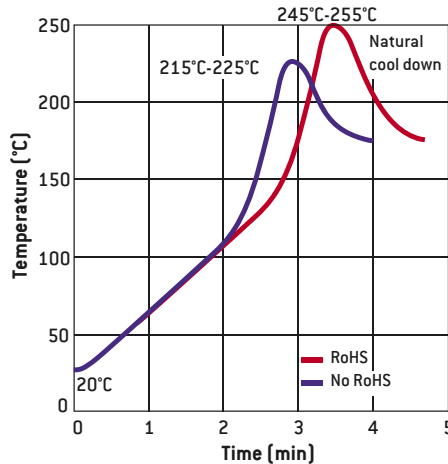

### RECOMMENDED WAVE SOLDERING PROFILE

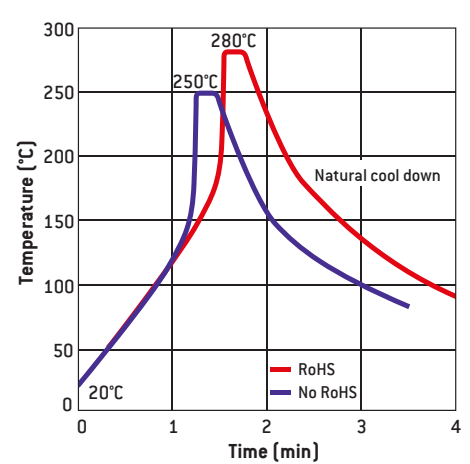

## SOLDERING ADVICES FOR IRON SOLDERING

Attachment with a soldering iron is discouraged due to ceramic brittleness and the process control limitations. In the event that a soldering iron must be used, the following precautions should be observed:

- Use a substrate with chip footprints big enough to allow putting side by side one end of the capacitor and the iron tip without any contact between this tip and the component,
- place the capacitor on this footprint,

- heat the substrate until the capacitor's temperature reaches 150°C minimum (preheating step, maximum 1°C per second),
- place the hot iron tip (a flat tip is preferred) on the footprint **without touching the capacitor**. Use a regulated iron with a 30 watts maximum power. The recommended temperature of the iron is 270 ±10°C. The temperature gap between the capacitor and the iron tip must not exceed 120°C,

# User Guide

- leave the tip on the footprint for a few seconds in order to increase locally the footprint's temperature,
- use a cored wire solder and put it down on the iron tip. In a preferred way use Sn/Pb/Ag 62/36/2 alloy,
- wait until the solder fillet is formed on the capacitor's termination,
- take away iron and wire solder,
- wait a few minutes so that the substrate and capacitor come back down to

the preheating temperature,

- solder the second termination using the same procedure as the first,
- let the soldered component cool down slowly to avoid any thermal shock.

## PACKAGING

### TAPE AND REEL

The films used on the reels correspond to standard IEC 60286-3. Films are delivered on reels in compliance with document IEC 286-3 dated 1991.

Minimum quantity is 250 chips.

Maximum quantities per reel are as follows:

- Super 8 reel - Ø 180: 2,500 chips.
- Super 8 reel - Ø 330: 10,000 chips.
- Super 12 reel - Ø 180: 1,000 chips.

Reel marking complies with CECC 32100 standard:

- Model.
- Rated capacitance.
- Capacitance tolerance.
- Rated voltage.
- Batch number.

### TRAY PACKAGES



### DIMENSIONAL CHARACTERISTICS OF CHIPS TRAY PACKAGES

Sizes	Nr. of chips/ package	Oriented chips	Dimensions in inches (in mm)				
			A	B	C	D	E
0402	100	No	0.0112 (0.302)		0.065 (1.65)	0.167 (4.24)	2 (50.8)
0403	100	No	0.0112 (0.302)		0.065 (1.65)	0.167 (4.24)	2 (50.8)
0504	100	Yes	0.059 (1.5)	0.045 (1.14)	0.035 (0.89)	0.167 (4.24)	2 (50.8)
0603	340	Yes	0.1 (2.54)	0.06 (1.52)	0.045 (1.14)	0.167 (4.24)	2 (50.8)
0805	100	Yes	0.1 (2.54)	0.06 (1.52)	0.045 (1.14)	0.167 (4.24)	2 (50.8)
1206	100	No	0.14 (3.56)	0.14 (3.56)	0.06 (1.52)	0.167 (4.24)	2 (50.8)
1210	100	Yes	0.14 (3.56)	0.14 (3.56)	0.06 (1.52)	0.167 (4.24)	2 (50.8)
1812	100	No	0.25 (6.35)	0.25 (6.35)	0.13 (3.3)	0.345 (8.76)	4 (101.6)
	25	Yes	0.24 (6.1)	0.265 (6.73)	0.07 (1.78)	0.345 (8.76)	2 (50.8)
2220	100	Yes	0.25 (6.35)	0.25 (6.35)	0.13 (3.3)	0.345 (8.76)	4 (101.6)
	25	Yes	0.24 (6.1)	0.265 (6.73)	0.07 (1.78)	0.345 (8.76)	2 (50.8)

### HIGH Q CAPACITORS TAPE AND REEL PACKAGING SPECIFICATIONS



Sizes	Type (1)	W±0.3 inches (mm)	F±0.05 inches (mm)	P1±0.1 inches (mm)	T max. inches (mm)	Reel Size inches (mm)	Quantity per Reel
A (0505)	H	0,315 (8)	0,138 (3.5)	0,157 (4)	0,010 (0,25)	7,087 (180)	3'000
A (0505)	V	0,315 (8)	0,138 (3.5)	0,157 (4)	0,010 (0,25)	7,087 (180)	3'000
S (0603)	H	0,315 (8)	0,138 (3.5)	0,157 (4)	0,016 (0,4)	7,087 (180)	4'000
F (0805)	H	0,315 (8)	0,138 (3.5)	0,157 (4)	0,016 (0,4)	7,087 (180)	4'000
B (1111)	H	0,315 (8)	0,138 (3.5)	0,157 (4)	0,012 (0,3)	7,087 (180)	1'000
B (1111)	V	0,315 (8)	0,138 (3.5)	0,157 (4)	0,010 (0,25)	7,087 (180)	1'000
X (2225)	H	0,472 (12)	0,138 (5.5)	0,472 (12)	0,018 (0,45)	12,992 (330)	500
E (4040)	H	0,945 (24)	0,453±0,004 (11.5±0.1)	0,630 (16)	0,018 (0,45)	12,992 (330)	700
E (4040)	V	1,260 (32)	0,559±0,004 (14.2±0.1)	0,945 (24)	0,022 (0,55)	15 (381)	350

(1): Horizontal (H) or Vertical (V) orientation in cavities.

# User Guide

## EIA STANDARD CAPACITANCE VALUES

Following EIA standard, the values and multiples that are indicated in the chart below can be ordered. E48, E96 series and intermediary values are available upon request.

E6 (± 20%)	E12 (± 10%)	E24 (± 5%)
10	10	10
	12	11
		12
15	15	13
		15
	18	16
		18
22	20	
	22	
	24	
33	27	
	30	
	33	
47	36	
	39	
	43	
68	47	
	51	
	56	
68	62	
	68	
	75	
	82	
	82	
	91	

## EIA CAPACITANCE CODE

The capacitance is expressed in three digit codes and in units of pico Farads (pF). The first and second digits are significant figures of the capacitance value and the third digit identifies the multiplier.

For capacitance value < 10pF, R designates a decimal point.  
See examples below:

EIA code	Capacitance value		
	in pF	in nF	in $\mu$ F
2R2	2.2	0.0022	0.0000022
6R8	6.8	0.0068	0.0000068
220	22	0.022	0.000022
470	47	0.047	0.000047
181	180	0.18	0.00018
221	220	0.22	0.00022
102	1,000	1	0.001
272	2,700	2.7	0.0027
123	12,000	12	0.012
683	68,000	68	0.068
124	120,000	120	0.12
564	560,000	560	0.56
335	3,300,000	3,300	3.3
825	8,200,000	8,200	8.2
156	15,000,000	15,000	15
686	68,000,000	68,000	68
107	100,000,000	100,000	100
227	220,000,000	220,000	220

## PART MARKING VOLTAGE CODES

Use the following voltage code chart for part markings:

Voltage (V)	Code	Letter code
25	250	A
40	400	B
50	500	C
63	630	D
100	101	E
200	201	G
250	251	H
400	401	K
500	501	L
1,000	102	M
2,000	202	P
3,000	302	R
4,000	402	S
5,000	502	T
7,500	752	U
10,000	103	W

## PART MARKING TOLERANCE CODES

Use the following tolerance code chart for part markings:

Tolerance	Letter code
±0.25pF	CU
±0.5pF	DU
±1pF	FU
±1%	F
±2%	G
±5%	J
±10%	K
±20%	M

# User Guide

## RELIABILITY LEVELS

Exxelia proposes different reliability levels for the ceramic capacitors for both NPO and X7R ceramics.

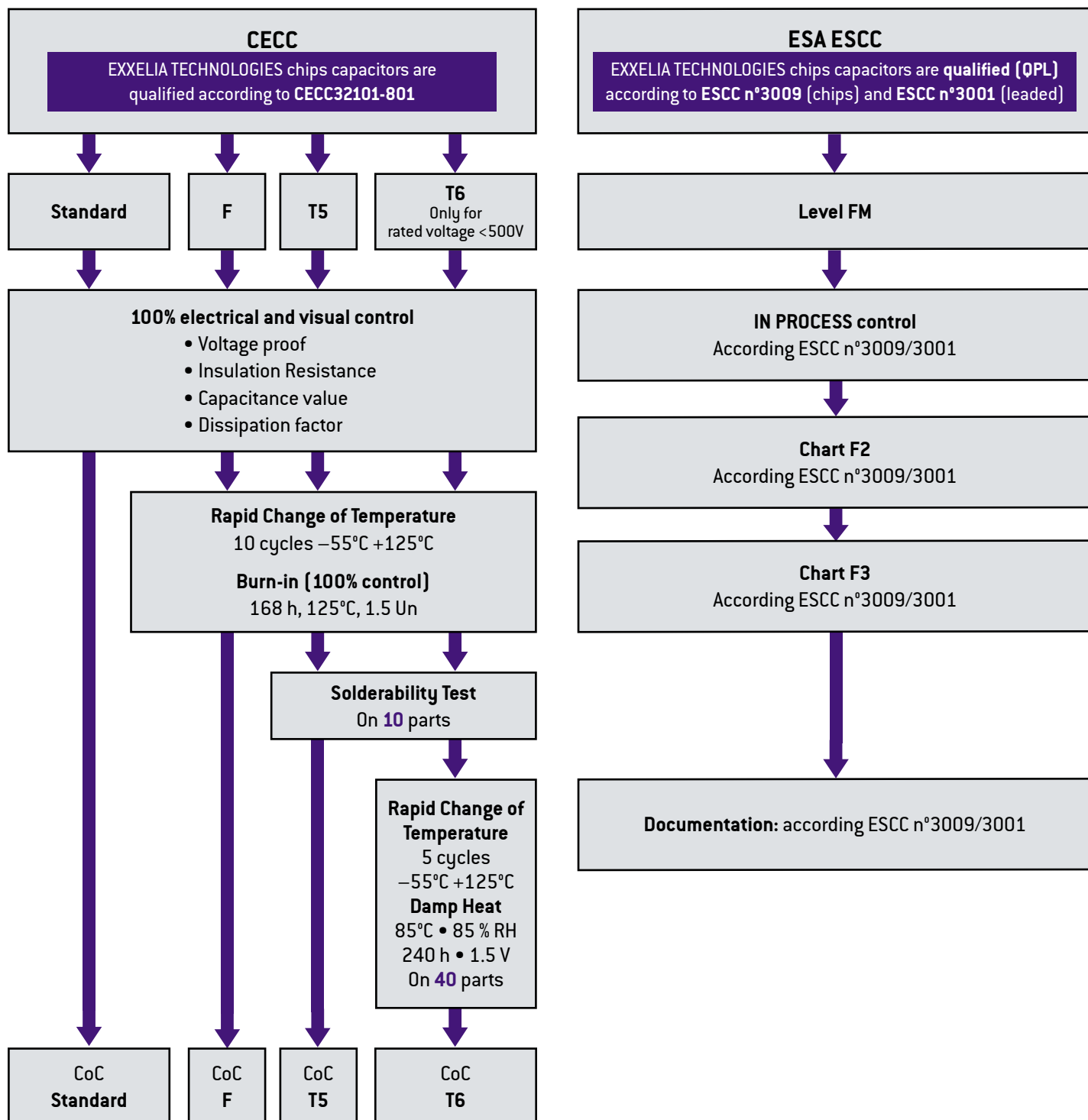

As the world's leading manufacturer of specific passive components, we stand apart through our ability to quickly evaluate the application specific engineering challenges and provide a cost-effective and efficient solutions.

For requirements that cannot be met by catalog products, we offer leading edge solutions in custom configuration: custom geometries, packaging, characteristics, all is possible thanks to our extensive experience and robust development process, while maintaining the highest level of reliability.

Where necessary, special testing is done to verify requirements, such as low dielectric absorption, ultra-high insulation resistance, low dissipation factor, stability under temperature cycling or under specified environmental conditions, etc.

**HIGH CAPACITANCE**

- High energy density
- Specific case sizes
- Specific shape of connections (high resistance to vibrations)

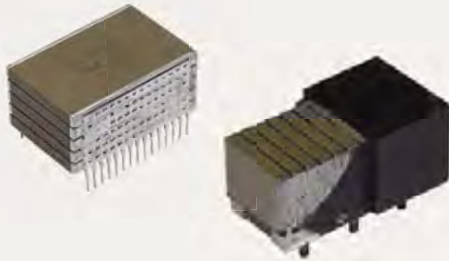

**HIGH VOLTAGE**

- Up to 50 kV
- Specific circular shape

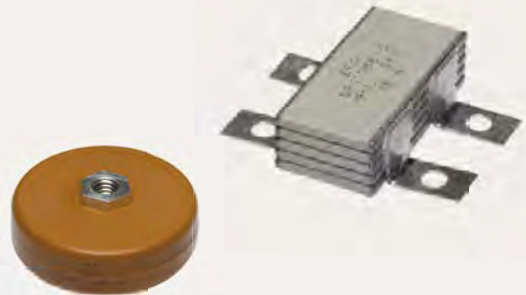

**HIGH TEMPERATURE**

- Up to 250°C
- Specific shape of connections
- 2,000 hours life time
- HMP soldering



**OTHERS**

- Screen printed resistors
- Complex components
- Full functions available

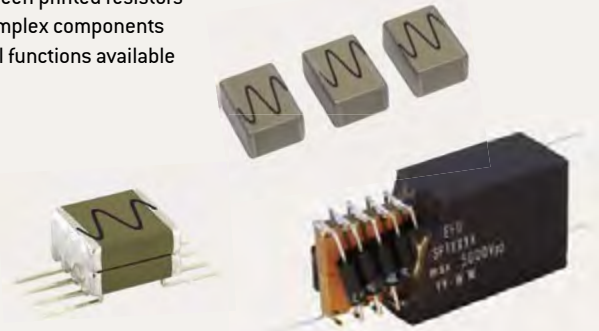

# General Information

## MATERIALS EXPERT

For 50 years and as a market leader, EXXELIA's comprehensive knowledge of the materials properties and performances have enabled us to design capacitors in Porcelain, NPO, BX, 2C1, BP, X7R and  $-2200\text{ppm}/^\circ\text{C}$  ceramics.

## CUSTOM DESIGNS

Our catalog products don't meet your application?

Based on the valuable experience accumulated over the design of 2,000+ specific ceramic capacitors, you can trust EXXELIA to define a qualitative custom solution in a time effective manner.

## NO OBSOLESCENCE

Choosing a standard or custom EXXELIA product means you won't have to worry about obsolescence.

## TYPICAL APPLICATIONS

- Aerospace & Defense: cockpit panels, flight control, radio systems, missile guidance systems...
- Space: military and commercial satellites, launcher...
- Medical: MRI, external defibrillators, implantable devices...
- Telecommunications: base stations...
- Oil and gas: drilling tools, MWD, LWD, wellheads...

## ISO 9001 AND AS9100C

Quality is at the core of Exxelia's corporate culture. Each sites has its own certifications.

## CERTIFICATIONS

Capacitors manufactured by EXXELIA comply with American and European standards and meet the requirements of many international standards. For Space qualified parts (ESA QPL), please refer to our catalog «Ceramic capacitors for Space applications».

## QUALITY & RELIABILITY

EXXELIA is committed to design and manufacture high quality and reliability products. The test cycles reproducing the most adverse operating conditions over extended periods (up to 10 000 hours) have logged to date well over  $5.10^9$  hours/ $^\circ\text{C}$ Component.

Failure rate data can be provided upon request.

## CONFLICT MINERALS

EXXELIA is committed to an approach based on «Conflict Minerals Compliance». This US SEC rule demands complete traceability and a control mechanism for the mineral procurement chain, encouraging importers to buy only «certified» ore.

We have discontinued relations with suppliers that procure from the Democratic Republic of the Congo or an adjoining country.

## ENVIRONMENT

EXXELIA is committed to applying a robust environmental policy, from product design through to shipment. To control its environmental footprint and reconcile this with the company's functional imperatives, our environmental policy provides for the reduction or elimination of hazardous substances. We also focus on compliance with European Union directives and regulations, notably REACH and RoHS.

## RoHS COMPLIANCE

### SMD CAPACITORS

The capacitor terminations are generally protected by a nickel barrier formed by electrolytic deposit. This barrier gives chip capacitors leaching performance far exceeding the requirements of all applicable standards. The nickel barrier guarantees a minimum resistance to soldering heat for a period of 1 minute at  $260^\circ\text{C}$  in a tin-lead (60/40) or tin-lead-silver (62/36/2) bath without noticeable alteration to the solderability. It also allows repeated soldering-unsoldering and the longer soldering times required by reflow techniques.

However nickel barrier amplifies thermal shock and is not recommended for chip sizes equal or greater than CNC Y (30 30) - [C 282 to C 288 - CNC 80 to CNC 94].

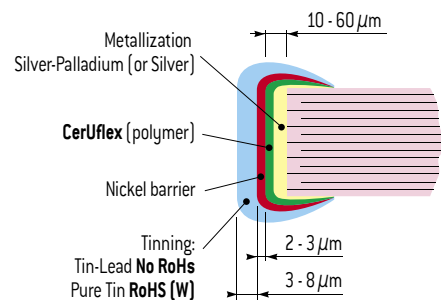

### LEADED COMPONENTS

As well as for SMD products, leaded capacitors ranges can also be RoHS. These products, which are characterized by the suffix «W» added to the commercial type, are naturally compatible with the soldering alloys used in RoHS mounting technology. The connections coating is generally an alloy SnAg (with a maximum of 4% Ag). However, on a few products that EXXELIA will precise on request, the coating is pure silver.