

CS Series

High Voltage Stacked Capacitors



FEATURES

- Multilayer chip ceramic capacitors stacked
- NPO, C4xx and X7R dielectrics
- Capacitance range: 220pf to 15 μ F
- Voltage range: 1,000 V_{DC} to 10,000 V_{DC}

PHYSICAL CHARACTERISTICS

CONSTRUCTION

- **P, PL, L models:** DIL leaded uncoated stacked chip capacitors for surface mounting recommended to eliminate thermomechanical stresses.
- **N, NU models:** DIL leaded stacked chip capacitors for through-hole circuits (N: varnished chips, NU: uncoated chips).
- **R, RU models:** Ribbon leaded stacked chip capacitors for surface mounting (R: varnished chips, RU: uncoated chips) recommended to eliminate thermomechanical stresses.

RECOMMENDED FOOTPRINT

See general information on high voltage capacitors (see page 50).

MARKING

Series, capacitance value, tolerance, rated voltage, date code.

ELECTRICAL SPECIFICATIONS

DIELECTRIC	NPO	C4xx	X7R
Dielectric code	1	4	2
Maximum $\Delta C/\text{°C}$ over temperature range without voltage	NA	NA	$\pm 15\%$
Temperature coefficient	(0 ± 30) ppm/°C	$(-2,200 \pm 500)$ ppm/°C	NA
Aging	None	None	$\leq 2.5\%$ per decade hour
Operating temperature	-55°C to $+125\text{°C}$		
Rated voltage (U _{RC})	1,000 V _{DC} to 10,000 V _{DC}	1,000 V _{DC} to 5,000 V _{DC}	1,000 V _{DC} to 10,000 V _{DC}
Dielectric withstanding voltage	1.3 U _{RC}	1.2 U _{RC}	1.2 U _{RC}
Capacitance	at 1MHz for C \leq 1,000pf at 1kHz for C > 1,000pf	at 1kHz	at 1kHz
Dissipation factor	$\leq 0.15\%$ at 1MHz for C \leq 1,000pf $\leq 0.15\%$ at 1kHz for C > 1,000pf	$\leq 0.10\%$ at 1kHz	$\leq 2.5\%$ at 1kHz
Insulation resistance at 25°C under U _{RC} for U _{RC} \leq 500 V under 500 V _{DC} for U _{RC} > 500 V	$\geq 100,000 \text{ M}\Omega$ for C \leq 10nf $\geq 1,000 \text{ M}\Omega \cdot \mu\text{F}$ for C > 10nf	$\geq 20,000 \text{ M}\Omega$ for C \leq 25nf $\geq 500 \text{ M}\Omega \cdot \mu\text{F}$ for C > 25nf	

HOW TO ORDER

CS	2	84	P	W	F	120nF	20%	2,000 V	-
Series	Dielectric code	Exxelia size code	Leads style	RoHS compliant	Quality level	Capacitance	Tolerance	Rated voltage	Reliability level
CS = High voltage stacked capacitor	1 = NPO 2 = X7R 4 = C4xx	80 81 82 83 84 89 85 87 88	P PL L R RU N NU	- = No RoHS W = RoHS compliant	- = standard quality level F = Hi-Rel quality: screening in accordance with Exxelia specification	Capacitance value in clear	NPO dielectric: $\pm 1\%$ $\pm 2\%$ $\pm 5\%$ $\pm 10\%$ $\pm 20\%$ C4xx dielectric: $\pm 2\%$ $\pm 5\%$ $\pm 10\%$ $\pm 20\%$ X7R dielectric: $\pm 10\%$ $\pm 20\%$	1,000 V 1,500 V 2,000 V 3,000 V 4,000 V 5,000 V 7,500 V 10,000 V Intermediary, lower and higher voltages available: contact your sales representative.	For F parts only. Acc. to Exxelia spec. - T5 T6 See page 15

High Voltage Stacked Capacitors

CS Series

DIMENSIONS in inches (mm)

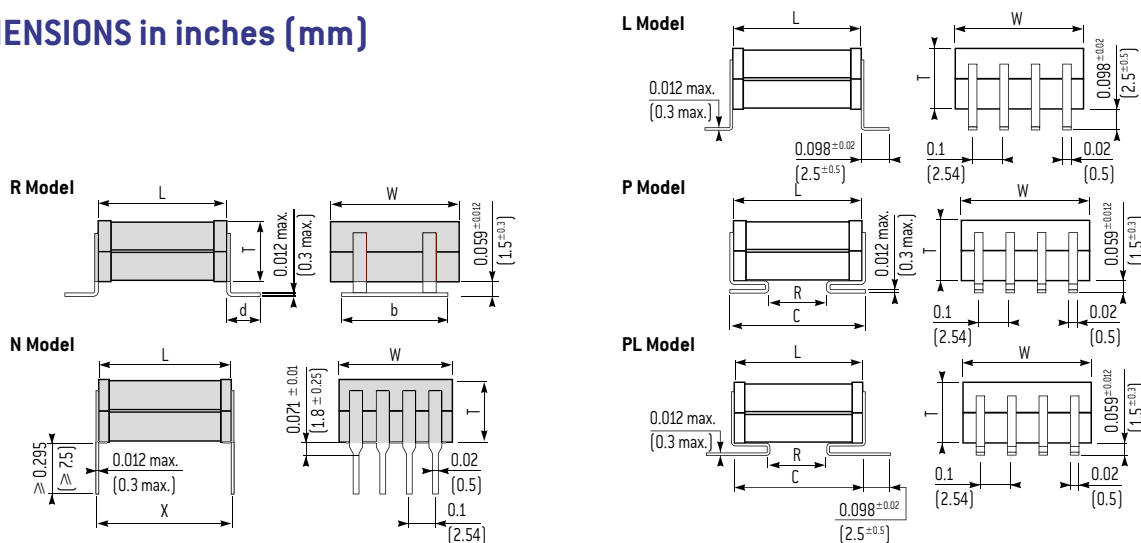

STANDARD RATINGS

Size	2220			2825			3333			4040			T max. inches (mm)	Nb. of chips
	Exxelia size code	80		81		82		83						
L		0.224 ± 0.020 (5.7 ± 0.5)		0.276 ± 0.020 (7 ± 0.5)		0.331 ± 0.020 (8.4 ± 0.5)		0.400 ± 0.039 (10.16 ± 1)						
W		0.197 ± 0.020 (5.0 ± 0.5)		0.250 ± 0.020 (6.35 ± 0.5)		0.331 ± 0.020 (8.4 ± 0.5)		0.400 ± 0.039 (10.16 ± 1)						
d		0.087 ± 0.008 (2.2 ± 0.2)		0.087 ± 0.008 (2.2 ± 0.2)		0.138 ± 0.008 (3.5 ± 0.2)		0.138 ± 0.008 (3.5 ± 0.2)						
b		0.197 ± 0.020 (5 ± 0.5)		0.197 ± 0.020 (5 ± 0.5)		0.315 ± 0.020 (8 ± 0.5)		0.315 ± 0.020 (8 ± 0.5)						
R min.		0.098 (2.5)		0.137 (3.5)		0.177 (4.5)		0.275 (7)						
C max.		0.276 (7)		0.315 (8)		0.355 (9)		0.473 (12)						
X		0.248 ± 0.020 (6.3 ± 0.5)		0.300 ± 0.020 (7.62 ± 0.5)		0.350 ± 0.020 (8.9 ± 0.5)		0.45 ± 0.020 (11.43 ± 0.5)						
Leads per side		2		2		3		4						

Dielectric	NPO			C4xx			X7R			T max. inches (mm)	Nb. of chips				
	1	4	2	1	4	2	1	4	2						
Exxelia ceramic code	1	4	2	1	4	2	1	4	2						
Min. Capacitance value	1nF	3.9nF	12nF	1nF	3.3nF	12nF	1.8nF	5.6nF	22nF	220pF	10nF	27nF			
Rated voltage (U _{DC})	1kV	12nF	39nF	100nF	18nF	56nF	180nF	39nF	100nF	270nF	68nF	220nF	560nF	0.394 (10)	2
		18nF	68nF	150nF	27nF	82nF	270nF	56nF	150nF	390nF	100nF	330nF	1µF	0.591 (15)	3
		-	-	-	-	-	-	-	-	-	-	-	-	0.788 (20)	4
		-	-	-	-	-	-	-	-	-	-	-	-	0.985 (25)	5
		-	-	-	-	-	-	-	-	-	-	-	-	0.394 (10)	2
	1.5kV	5.6nF	18nF	39nF	8.2nF	27nF	68nF	22nF	56nF	120nF	39nF	100nF	270nF	0.394 (10)	2
		8.2nF	27nF	56nF	12nF	39nF	100nF	33nF	68nF	180nF	56nF	150nF	390nF	0.591 (15)	3
		-	-	-	-	-	-	-	-	-	-	-	-	0.788 (20)	4
		-	-	-	-	-	-	-	-	-	-	-	-	0.985 (25)	5
		-	-	-	-	-	-	-	-	-	-	-	-	0.394 (10)	2
	2kV	3.3nF	10nF	22nF	4.7nF	18nF	39nF	8.2nF	27nF	68nF	18nF	56nF	150nF	0.394 (10)	2
		4.7nF	15nF	33nF	6.8nF	27nF	68nF	12nF	39nF	120nF	27nF	82nF	220nF	0.591 (15)	3
		-	-	-	-	-	-	-	-	-	-	-	-	0.788 (20)	4
		-	-	-	-	-	-	-	-	-	-	-	-	0.985 (25)	5
		-	-	-	-	-	-	-	-	-	-	-	-	0.394 (10)	2
	3kV	2.2nF	4.7nF	12nF	2.7nF	6.8nF	18nF	4.7nF	12nF	33nF	10nF	27nF	68nF	0.394 (10)	2
		3.3nF	6.8nF	18nF	3.9nF	10nF	27nF	6.8nF	22nF	47nF	15nF	39nF	100nF	0.591 (15)	3
		-	-	-	-	-	-	-	-	-	-	-	-	0.788 (20)	4
		-	-	-	-	-	-	-	-	-	-	-	-	0.985 (25)	5
		-	-	-	-	-	-	-	-	-	-	-	-	0.394 (10)	2
	4kV	1nF	2.7nF	5.6nF	1.8nF	3.3nF	12nF	3.3nF	6.8nF	22nF	5.6nF	15nF	39nF	0.394 (10)	2
		1.5nF	3.9nF	8.2nF	2.7nF	4.7nF	18nF	4.7nF	10nF	33nF	8.2nF	22nF	56nF	0.591 (15)	3
		-	-	-	-	-	-	-	-	-	-	-	-	0.788 (20)	4
		-	-	-	-	-	-	-	-	-	-	-	-	0.985 (25)	5
-		-	-	-	-	-	-	-	-	-	-	-	0.394 (10)	2	
5kV	560pF	1.5nF	3.9nF	1.2nF	2.2nF	8.2nF	2.2nF	3.9nF	12nF	3.9nF	8.2nF	27nF	0.394 (10)	2	
	820pF	2.7nF	5.6nF	1.8nF	3.3nF	12nF	3.3nF	5.6nF	18nF	5.6nF	12nF	39nF	0.591 (15)	3	
	-	-	-	-	-	-	-	-	-	-	-	-	0.788 (20)	4	
	-	-	-	-	-	-	-	-	-	-	-	-	0.985 (25)	5	
	-	-	-	-	-	-	-	-	-	-	-	-	0.394 (10)	2	
7.5kV	-	-	-	-	-	-	-	-	-	820pF	-	8.2nF	0.394 (10)	2	
	-	-	-	-	-	-	-	-	-	1.2nF	-	12nF	0.591 (15)	3	
	-	-	-	-	-	-	-	-	-	-	-	-	0.788 (20)	4	
	-	-	-	-	-	-	-	-	-	-	-	-	0.985 (25)	5	
	-	-	-	-	-	-	-	-	-	-	-	-	0.394 (10)	2	
10kV	-	-	-	-	-	-	-	-	-	560pF	-	4.7nF	0.394 (10)	2	
	-	-	-	-	-	-	-	-	-	820pF	-	6.8nF	0.591 (15)	3	
	-	-	-	-	-	-	-	-	-	-	-	-	0.788 (20)	4	

Due to flashover risks, please consult us for these capacitance values.

STANDARD RATINGS

Size	5440			5550			6560			11283			16080						
Exxelia size code	84			89			85			87			88						
Dimensions inches (mm)	L	0.539 ± 0.039 (13.7 ± 1)			0.551 ± 0.039 (14 ± 1)			0.650 ± 0.039 (16.5 ± 1)			1.122 ± 0.039 (28.5 ± 1)			1.555 ± 0.039 (39.5 ± 1)					
	W	0.400 ± 0.039 (10.16 ± 1)			0.500 ± 0.039 (12.7 ± 1)			0.598 ± 0.039 (15.2 ± 1)			0.827 ± 0.039 (21 ± 1)			0.756 ± 0.039 (19.2 ± 1)					
	d	0.138 ± 0.008 (3.5 ± 0.2)			0.138 ± 0.008 (3.5 ± 0.2)			0.138 ± 0.008 (3.5 ± 0.2)			0.138 ± 0.008 (3.5 ± 0.2)			0.138 ± 0.008 (3.5 ± 0.2)					
	b	0.315 ± 0.020 (8 ± 0.5)			0.315 ± 0.020 (8 ± 0.5)			0.591 ± 0.020 (15 ± 0.5)			0.591 ± 0.020 (15 ± 0.5)			0.591 ± 0.020 (15 ± 0.5)					
	R min.	0.393 (10)			0.393 (10)			0.511 (13)			0.984 (25)			1.377 (35)					
	C max.	0.611 (15.5)			0.63 (16)			0.729 (18.5)			1.26 (32)			1.654 (42)					
	X	0.552 ± 0.020 (14 ± 0.5)			0.563 ± 0.020 (14.3 ± 0.5)			0.7 ± 0.020 (17.78 ± 0.5)			1.15 ± 0.020 (29.21 ± 0.5)			1.6 ± 0.020 (40.64 ± 0.5)					
Leads per side	4			5			6			6			6						
Dielectric	NPO	C4xx	X7R	NPO	C4xx	X7R	NPO	C4xx	X7R	NPO	C4xx	X7R	NPO	C4xx	X7R	T max. inches (mm)	Nb. of chips		
Exxelia ceramic code	1	4	2	1	4	2	1	4	2	1	4	2	1	4	2				
Min Capacitance value	3.9nF	6.8nF	22nF	4.7nF	12nF	27nF	6.8nF	18nF	39nF	2.2nF	39nF	15nF	3.3nF	47nF	27nF				
Rated voltage (U _{rated})	1kV	100nF	270nF	820nF	120nF	390nF	1µF	220nF	560nF	1.8µF	470nF	1.5µF	3.9µF	560nF	1.8µF	5.6µF	0.394	(10)	2
		150nF	390nF	1.2µF	180nF	560nF	1.5µF	330nF	820nF	2.7µF	680nF	2.2µF	5.6µF	820nF	2.2µF	8.2µF	0.591	(15)	3
		220nF	560nF	1.8µF	270nF	820nF	2.2µF	470nF	1.2µF	3.3µF	1µF	3.3µF	6.8µF	1.2µF	3.9µF	10µF	0.788	(20)	4
		-	-	-	330nF	1µF	2.7µF	560nF	1.5µF	3.9µF	1.2µF	3.9µF	10µF	1.5µF	4.7µF	15µF	0.985	(25)	5
	1.5kV	47nF	120nF	390nF	68nF	180nF	470nF	100nF	270nF	680nF	270nF	680nF	1.5µF	330nF	820nF	2.2µF	0.394	(10)	2
		68nF	180nF	560nF	100nF	270nF	680nF	150nF	390nF	1µF	390nF	1µF	2.2µF	470nF	1.2µF	3.3µF	0.591	(15)	3
		100nF	270nF	820nF	150nF	390nF	1µF	220nF	560nF	1.5µF	560nF	1.5µF	2.7µF	680nF	1.8µF	4.7µF	0.788	(20)	4
		-	-	-	180nF	470nF	1.2µF	270nF	680nF	1.8µF	680nF	1.8µF	3.9µF	820nF	2.2µF	5.6µF	0.985	(25)	5
	2kV	27nF	68nF	220nF	33nF	100nF	270nF	47nF	150nF	390nF	82nF	390nF	1µF	120nF	470nF	1.2µF	0.394	(10)	2
		39nF	100nF	330nF	47nF	150nF	390nF	68nF	220nF	560nF	120nF	560nF	1.5µF	180nF	680nF	1.8µF	0.591	(15)	3
		56nF	150nF	470nF	68nF	220nF	560nF	100nF	270nF	820nF	180nF	820nF	1.8µF	270nF	1µF	2.7µF	0.788	(20)	4
		-	-	-	82nF	270nF	680nF	120nF	390nF	1µF	220nF	1µF	2.7µF	330nF	1.2µF	3.3µF	0.985	(25)	5
	3kV	15nF	27nF	100nF	22nF	47nF	120nF	27nF	68nF	180nF	56nF	180nF	390nF	82nF	220nF	560nF	0.394	(10)	2
		22nF	39nF	150nF	33nF	68nF	180nF	39nF	100nF	270nF	82nF	270nF	680nF	120nF	330nF	820nF	0.591	(15)	3
		27nF	56nF	220nF	47nF	100nF	270nF	56nF	150nF	390nF	120nF	390nF	820nF	180nF	470nF	1.2µF	0.788	(20)	4
		-	-	-	56nF	120nF	330nF	68nF	180nF	470nF	150nF	470nF	1.2µF	220nF	560nF	1.5µF	0.985	(25)	5
	4kV	8.2nF	15nF	56nF	10nF	33nF	82nF	18nF	39nF	120nF	33nF	82nF	220nF	47nF	120nF	330nF	0.394	(10)	2
		12nF	22nF	82nF	15nF	47nF	120nF	27nF	56nF	180nF	47nF	120nF	330nF	68nF	180nF	470nF	0.591	(15)	3
		18nF	27nF	120nF	22nF	68nF	180nF	39nF	82nF	270nF	68nF	180nF	470nF	100nF	270nF	680nF	0.788	(20)	4
		-	-	-	27nF	82nF	220nF	47nF	100nF	330nF	82nF	220nF	560nF	120nF	330nF	820nF	0.985	(25)	5
	5kV	5.6nF	8.2nF	39nF	6.8nF	18nF	47nF	12nF	22nF	68nF	22nF	56nF	150nF	33nF	68nF	180nF	0.394	(10)	2
		8.2nF	12nF	56nF	10nF	27nF	68nF	18nF	33nF	100nF	33nF	82nF	180nF	47nF	100nF	270nF	0.591	(15)	3
		12nF	18nF	82nF	15nF	39nF	100nF	27nF	47nF	150nF	47nF	120nF	270nF	68nF	150nF	390nF	0.788	(20)	4
		-	-	-	18nF	47nF	120nF	33nF	56nF	180nF	56nF	150nF	330nF	82nF	180nF	470nF	0.985	(25)	5
	7.5kV	1nF	-	12nF	1.5nF	-	15nF	2.2nF	-	22nF	5.6nF	-	56nF	8.2nF	-	82nF	0.394	(10)	2
		1.5nF	-	18nF	2.2nF	-	22nF	3.3nF	-	33nF	8.2nF	-	82nF	12nF	-	120nF	0.591	(15)	3
		2.2nF	-	27nF	2.7nF	-	27nF	4.7nF	-	47nF	12nF	-	120nF	18nF	-	180nF	0.788	(20)	4
		-	-	-	3.9nF	-	39nF	5.6nF	-	56nF	15nF	-	150nF	22nF	-	220nF	0.985	(25)	5
	10kV	680pF	-	5.6nF	1nF	-	6.8nF	1.5nF	-	12nF	3.9nF	-	27nF	5.6nF	-	39nF	0.394	(10)	2
		1nF	-	8.2nF	1.5nF	-	10nF	2.2nF	-	18nF	5.6nF	-	39nF	8.2nF	-	56nF	0.591	(15)	3
1.5nF		-	12nF	2.2nF	-	15nF	2.7nF	-	27nF	8.2nF	-	56nF	12nF	-	82nF	0.788	(20)	4	
-		-	-	2.7nF	-	18nF	3.9nF	-	33nF	10nF	-	68nF	15nF	-	100nF	0.985	(25)	5	

The high voltage parts may require varnish or encapsulation to prevent surface arcing.

Available capacitance values:

NPO, C4xx dielectrics: E6, E12, E24 (see page 14). Specific values upon request.

X7R dielectric: E6, E12 in standard (see page 14). Specific values upon request.

The above table defines the standard products, other components may be built upon request.

Due to flashover risks, please consult us for these capacitance values.

General Information

High voltage multilayer ceramic capacitors designed by EXXELIA are adapted to applications in electronics such as high voltage power supplies and high voltage multiplier circuits. Their multilayer construction offers significant size and space saving advantages. They are available in class 1 (NPO), class 2 (X7R) and C4xx (-2,200 ppm/°C) dielectrics versions complying with the main requirements of applicable standards. They are suited for use in commercial, industrial and High-Rel military and space circuits.

As standard products can't meet all the specificities of all applications, special applications may require specific features (higher voltage, burn-in, dimensions, coating, leading, marking...) not described in this catalogue. Based on our state-of-the-art technologies and our expertise, our Engineers may study at your request all special components to meet your application.

Please, consult us for more information.

NPO, X7R, C4xx: SELF-RESONANCE FREQUENCY VS CAPACITANCE

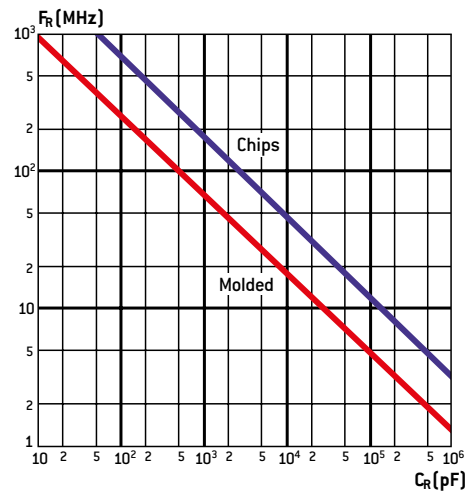

NPO/COG DIELECTRICS (CLASS 1)

Made of titanium oxide and other various selected oxides, they feature unique stability of all parameters under such constraints as operating time, temperature, voltage applied. For example, the quality factor remains very high over an extremely wide frequency range. As example, loss angle tangent value at 1MHz is typically in the order of $3 \cdot 10^{-4}$. These characteristics make them compatible with steep-edge impulse mode without noticeable temperature rise. The different parameters and related variations are illustrated in figures below:

NPO: RELATIVE CAPACITANCE CHANGE VS TEMPERATURE

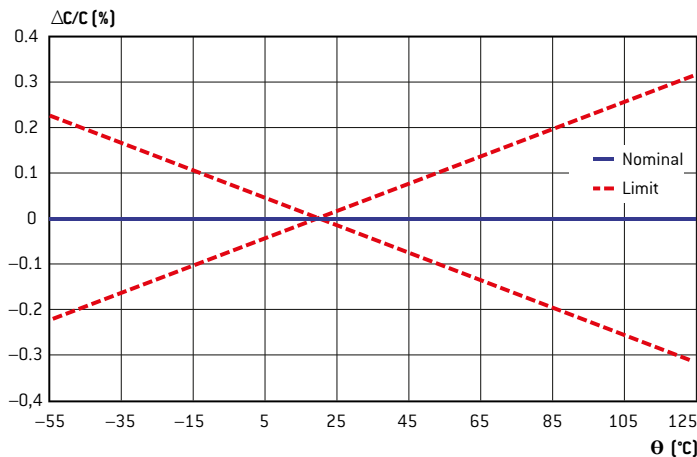

NPO: IMPEDANCE VS FREQUENCY

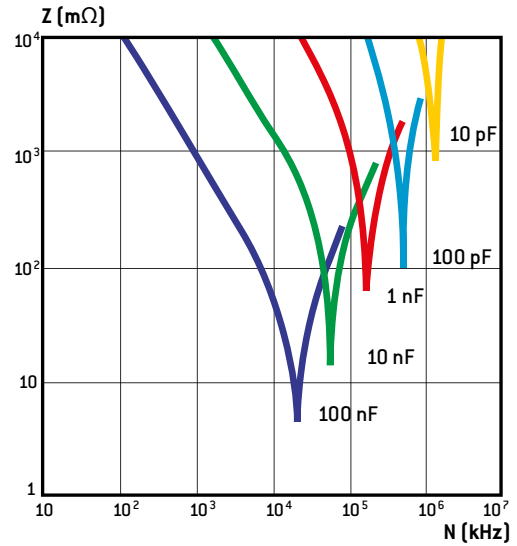

NPO: LOSS TANGENT VS TEMPERATURE

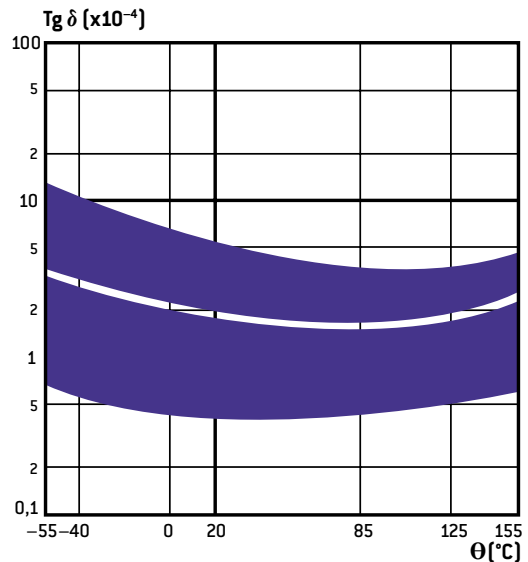

NPO: INSULATION RESISTANCE VS TEMPERATURE

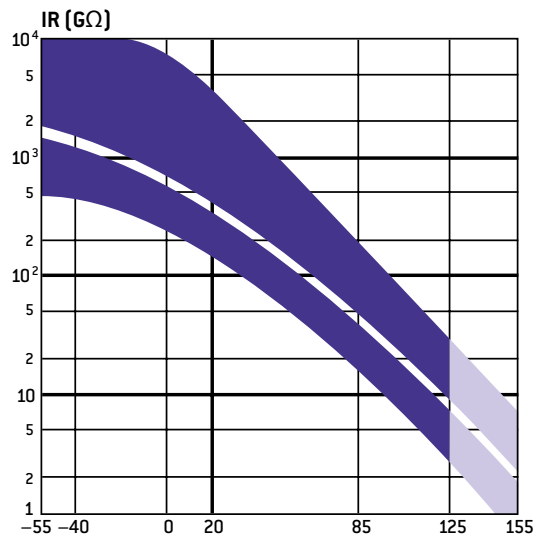

General Information

X7R DIELECTRICS (CLASS 2)

They are mainly made of barium titanate modified by various oxides to achieve the electrical properties required. A specific ceramic dielectric is used to achieve an excellent dielectric strength. High dielectric constant enables to achieve high capacitance values.

For optimum use, the specific properties of barium titanate in function of the different parameters must be taken into account.

See the variations illustrated in figures below:

CHANGE VS PERCENTAGE OF RATED VOLTAGE APPLIED

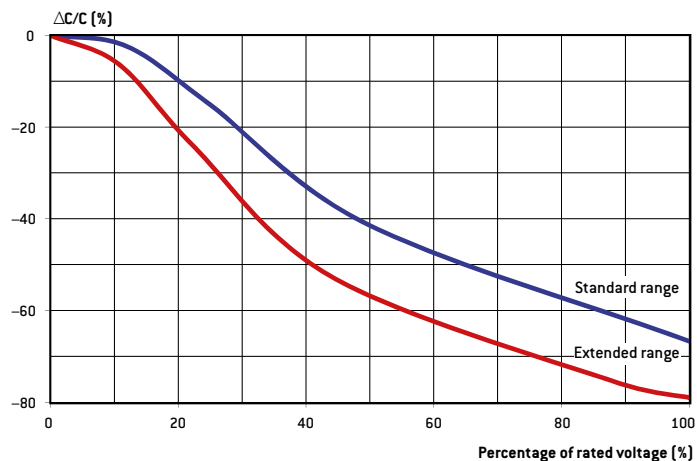

X7R: CAPACITANCE CHANGE VS TEMPERATURE

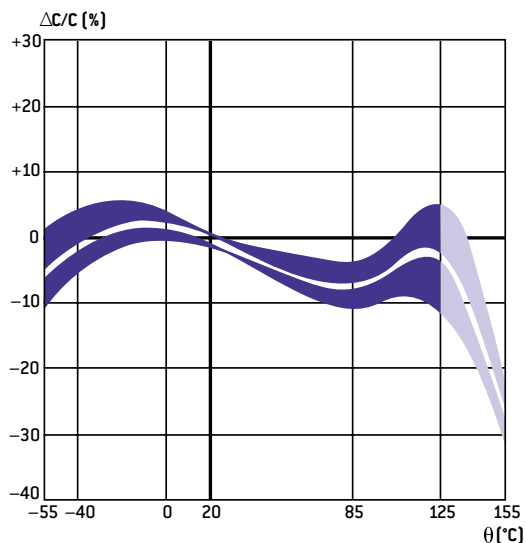

X7R: CAPACITANCE CHANGE VS FREQUENCY

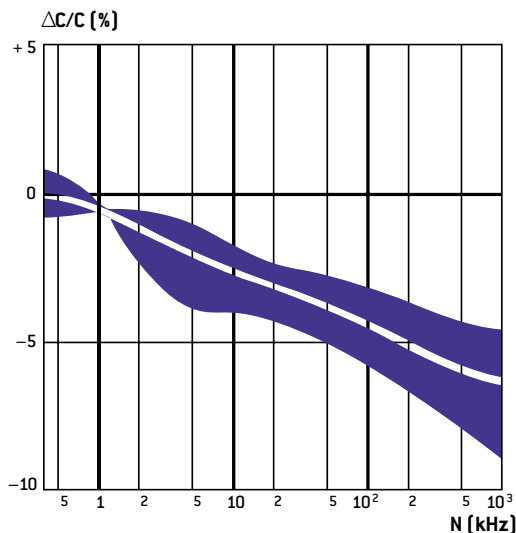

X7R: INSULATION RESISTANCE VS TEMPERATURE

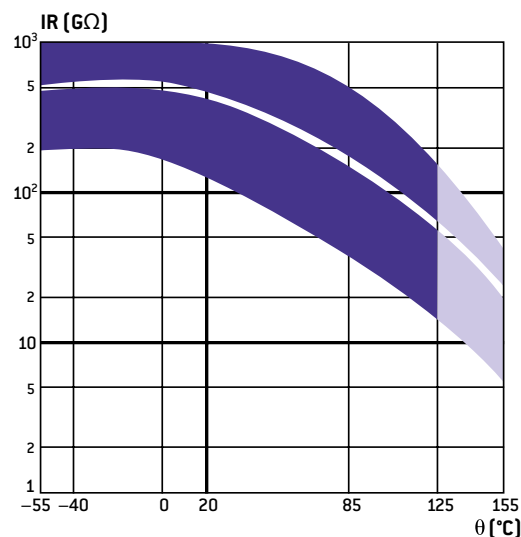

HIGH VOLTAGE

General Information

X7R: LOSS TANGENT CHANGE VS TEMPERATURE

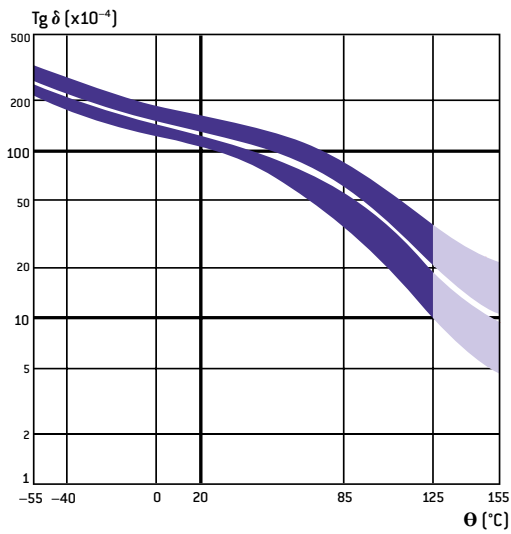

X7R: MAXIMUM ADMISSIBLE CURRENT VS FREQUENCY

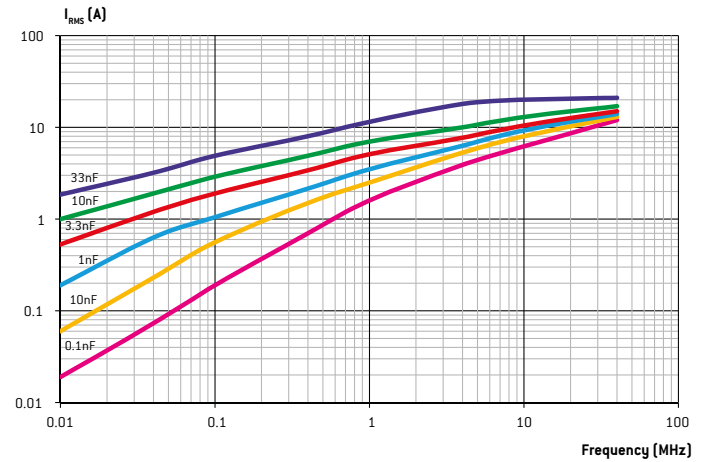

These typical curves are examples of admissible currents for one family of chip capacitors (size 3333). For other curves and products or for further information, please contact us.

Note: for the calculations, we have considered that the terminations are directly connected to an infinite heat sink. In other words, the thermal resistance of the circuit itself which depends on its type and design has not been taken into account. Moreover, the ambient temperature taken is 25°C.

X7R: LOSS TANGENT CHANGE VS FREQUENCY

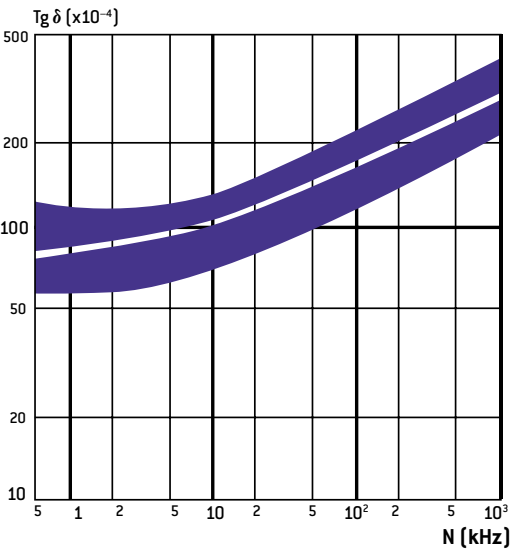

X7R: ESR VS FREQUENCY

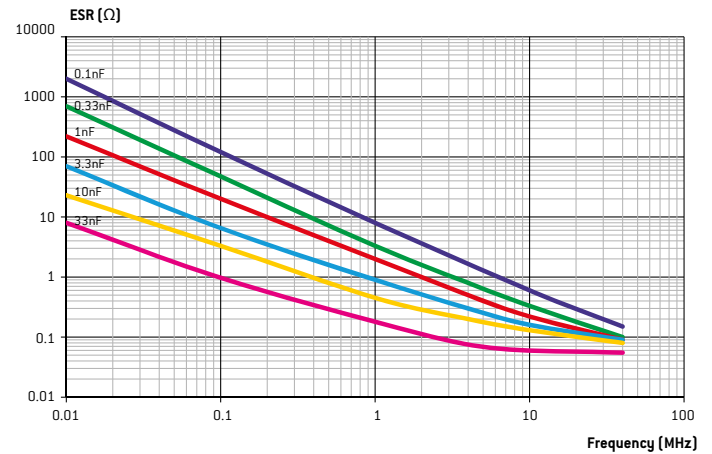

The ESR (Equivalent Serial Resistance) typical curves are given, here for SMD (chip) capacitors. Regarding the curves for the leaded capacitors, they are rather the same. Indeed, due to the resistivity of the raw material used and the wire diameters, the resistance of the wires is much lower than the ESR of the chips. So, in a first approach, their influence can be considered as negligible.

General Information

C4xx DIELECTRIC

This ceramic is a negative temperature coefficient dielectric (-2,200 ppm/°C). Its advantage is that it combines the high dielectric constant of an X7R dielectric with the stability of an NPO dielectric. As the C4xx ceramic features low dissipation factor it is recommended for AC line filtering from 110 Vrms to 230 Vrms, 20 to 400 Hz, for high power RF at high voltage up to 5,000 V and for pulse applications.

C4xx: TEMPERATURE COEFFICIENT

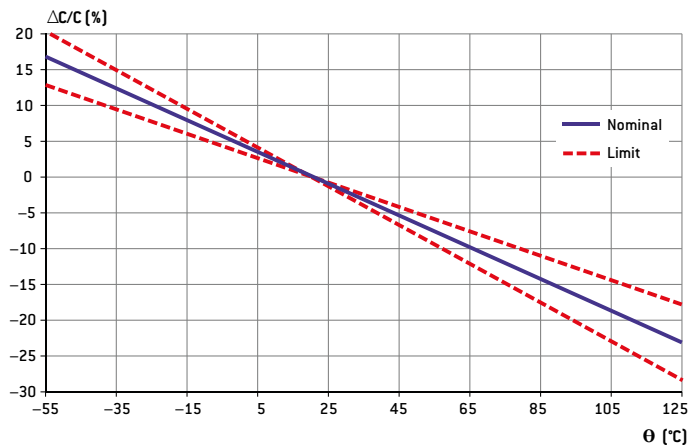

C4xx: VOLTAGE COEFFICIENT

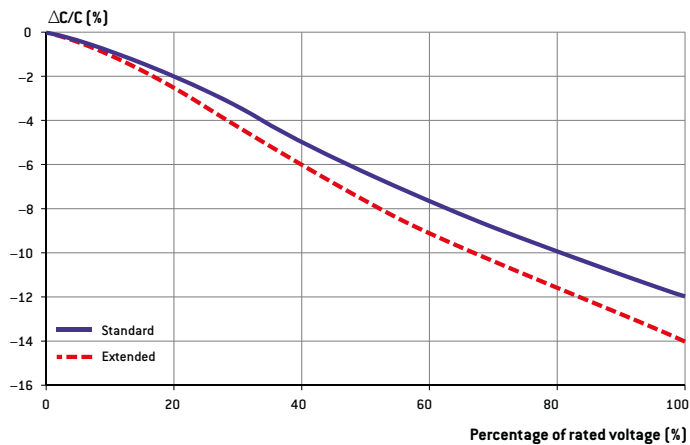

COMPARISON OF CAPACITANCE VALUE UNDER RATED VOLTAGE AT 125°C

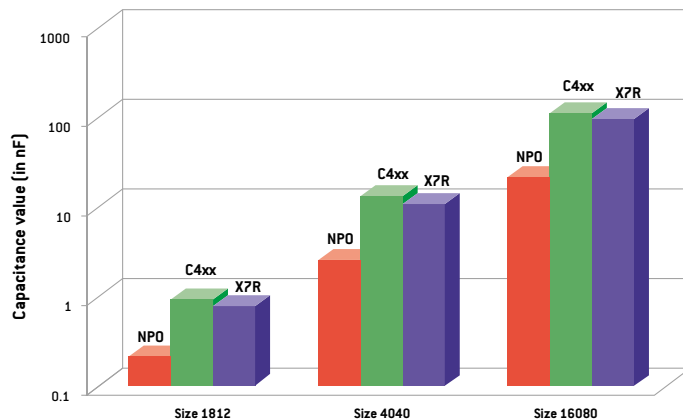

HIGH VOLTAGE

COMPARISON OF SELF-HEATING AT 400 Hz BETWEEN C4xx AND X7R DIELECTRICS

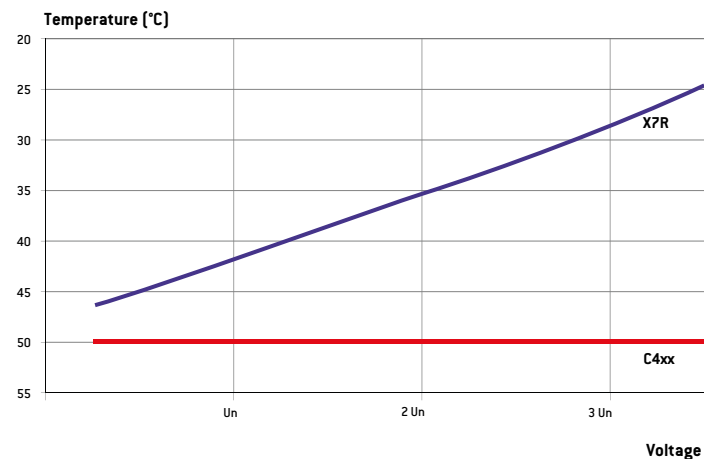

General Information

RECOMMENDED FOOTPRINTS

P* Model

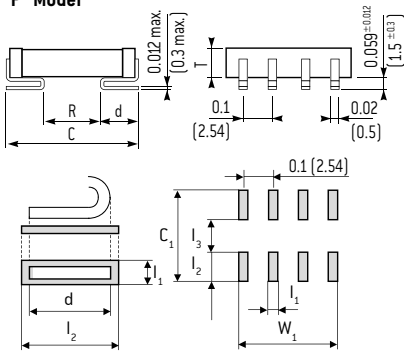

R Model

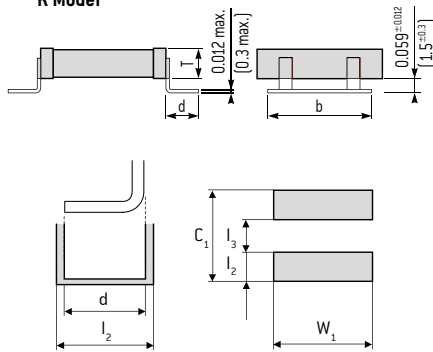

L Model

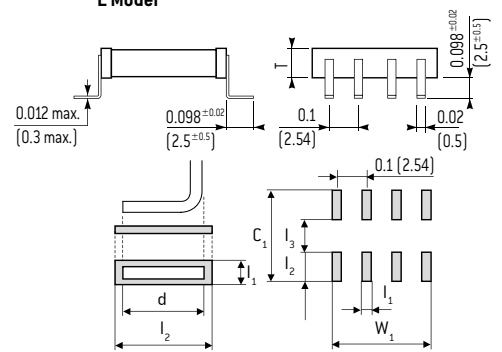

DIMENSIONS in inches (mm)

Exxelia size code	Lead shape	C max inches (mm)	Leads per side	d inches (mm)	b inches (mm)	C ₁ inches (mm)	W ₁ inches (mm)	I ₁ inches (mm)	I ₂ inches (mm)	I ₃ inches (mm)
90	P*	0.228 (5.8)	2	0.06 ± 0.012 (1.5 ± 0.3)	-	0.268 (6.8)	0.147 (3.74)	0.047 (1.2)	0.108 (2.75)	0.098 (2.5)
	L	0.394 (10)	2	0.098 ± 0.02 (2.5 ± 0.5)	-	0.433 (11)	0.147 (3.74)	0.047 (1.2)	0.152 (3.85)	0.130 (3.3)
	R	0.386 (9.8)	1	0.087 ± 0.008 (2.2 ± 0.2)	0.197 ± 0.02 (5 ± 0.5)	0.425 (10.8)	0.244 (6.2)	-	0.148 (3.75)	0.130 (3.3)
80	P*	0.276 (7)	2	0.06 ± 0.012 (1.5 ± 0.3)	-	0.315 (8)	0.147 (3.74)	0.047 (1.2)	0.108 (2.75)	0.098 (2.5)
	L	0.480 (12.2)	2	0.098 ± 0.02 (2.5 ± 0.5)	-	0.520 (13.2)	0.147 (3.74)	0.047 (1.2)	0.171 (4.35)	0.177 (4.5)
	R	0.433 (11)	1	0.087 ± 0.008 (2.2 ± 0.2)	0.197 ± 0.02 (5 ± 0.5)	0.472 (12)	0.244 (6.2)	-	0.148 (3.75)	0.177 (4.5)
91	P*	0.276 (7)	2	0.06 ± 0.012 (1.5 ± 0.3)	-	0.315 (8)	0.147 (3.74)	0.047 (1.2)	0.108 (2.75)	0.098 (2.5)
	L	0.480 (12.2)	2	0.098 ± 0.02 (2.5 ± 0.5)	-	0.520 (13.2)	0.147 (3.74)	0.047 (1.2)	0.171 (4.35)	0.177 (4.5)
	R	0.433 (11)	1	0.087 ± 0.008 (2.2 ± 0.2)	0.197 ± 0.02 (5 ± 0.5)	0.472 (12)	0.244 (6.2)	-	0.148 (3.75)	0.177 (4.5)
81	P*	0.315 (8)	2	0.087 ± 0.012 (2.2 ± 0.3)	-	0.354 (9)	0.147 (3.74)	0.047 (1.2)	0.108 (2.75)	0.138 (3.5)
	L	0.531 (13.5)	2	0.098 ± 0.02 (2.5 ± 0.5)	-	0.571 (14.5)	0.147 (3.74)	0.047 (1.2)	0.171 (4.35)	0.228 (5.8)
	R	0.484 (12.3)	1	0.087 ± 0.008 (2.2 ± 0.2)	0.197 ± 0.02 (5 ± 0.5)	0.524 (13.3)	0.244 (6.2)	-	0.148 (3.75)	0.228 (5.8)
82	P*	0.354 (9)	3	0.087 ± 0.012 (2.2 ± 0.3)	-	0.394 (10)	0.247 (6.28)	0.047 (1.2)	0.108 (2.75)	0.177 (4.5)
	L	0.587 (14.9)	3	0.098 ± 0.02 (2.5 ± 0.5)	-	0.626 (15.9)	0.247 (6.28)	0.047 (1.2)	0.171 (4.35)	0.283 (7.2)
	R	0.642 (16.3)	1	0.138 ± 0.008 (3.5 ± 0.2)	0.315 ± 0.02 (8 ± 0.5)	0.681 (17.3)	0.362 (9.2)	-	0.199 (5.05)	0.283 (7.2)
83	P*	0.472 (12)	4	0.087 ± 0.012 (2.2 ± 0.3)	-	0.512 (13)	0.347 (8.82)	0.047 (1.2)	0.118 (3)	0.276 (7)
	L	0.676 (17.16)	4	0.098 ± 0.02 (2.5 ± 0.5)	-	0.715 (18.16)	0.347 (8.82)	0.047 (1.2)	0.191 (4.85)	0.333 (8.46)
	R	0.731 (18.56)	1	0.138 ± 0.008 (3.5 ± 0.2)	0.315 ± 0.02 (8 ± 0.5)	0.770 (19.56)	0.362 (9.2)	-	0.219 (5.55)	0.333 (8.46)
84	P*	0.610 (15.5)	4	0.087 ± 0.012 (2.2 ± 0.3)	-	0.650 (16.5)	0.347 (8.82)	0.047 (1.2)	0.128 (3.25)	0.394 (10)
	L	0.815 (20.7)	4	0.098 ± 0.02 (2.5 ± 0.5)	-	0.854 (21.7)	0.347 (8.82)	0.047 (1.2)	0.191 (4.85)	0.472 (12)
	R	0.870 (22.1)	1	0.138 ± 0.008 (3.5 ± 0.2)	0.315 ± 0.02 (8 ± 0.5)	0.909 (23.1)	0.362 (9.2)	-	0.219 (5.55)	0.472 (12)
89	P*	0.630 (16)	5	0.087 ± 0.012 (2.2 ± 0.3)	-	0.669 (17)	0.347 (8.82)	0.047 (1.2)	0.128 (3.25)	0.413 (10.5)
	L	0.827 (21)	5	0.098 ± 0.02 (2.5 ± 0.5)	-	0.866 (22)	0.347 (8.82)	0.047 (1.2)	0.191 (4.85)	0.484 (12.3)
	R	0.882 (22.4)	1	0.138 ± 0.008 (3.5 ± 0.2)	0.315 ± 0.02 (8 ± 0.5)	0.921 (23.4)	0.362 (9.2)	-	0.219 (5.55)	0.484 (12.3)
85	P*	0.728 (18.5)	6	0.087 ± 0.012 (2.2 ± 0.3)	-	0.768 (19.5)	0.547 (13.9)	0.047 (1.2)	0.128 (3.25)	0.512 (13)
	L	0.925 (23.5)	6	0.098 ± 0.02 (2.5 ± 0.5)	-	0.965 (24.5)	0.547 (13.9)	0.047 (1.2)	0.191 (4.85)	0.583 (14.8)
	R	0.980 (24.9)	1	0.138 ± 0.008 (3.5 ± 0.2)	0.591 ± 0.02 (15 ± 0.5)	1.020 (25.9)	0.638 (16.2)	-	0.219 (5.55)	0.583 (14.8)
87	P*	1.260 (32)	6	0.087 ± 0.012 (2.2 ± 0.3)	-	1.299 (33)	0.547 (13.9)	0.047 (1.2)	0.128 (3.25)	0.945 (24)
	L	1.398 (35.5)	6	0.098 ± 0.02 (2.5 ± 0.5)	-	1.437 (36.5)	0.547 (13.9)	0.047 (1.2)	0.191 (4.85)	1.055 (26.8)
	R	1.453 (36.9)	1	0.138 ± 0.008 (3.5 ± 0.2)	0.591 ± 0.02 (15 ± 0.5)	1.492 (37.9)	0.638 (16.2)	-	0.219 (5.55)	1.055 (26.8)
88	P*	1.654 (42)	6	0.087 ± 0.012 (2.2 ± 0.3)	-	1.693 (43)	0.547 (13.9)	0.047 (1.2)	0.128 (3.25)	1.378 (35)
	L	1.831 (46.5)	6	0.098 ± 0.02 (2.5 ± 0.5)	-	1.870 (47.5)	0.547 (13.9)	0.047 (1.2)	0.191 (4.85)	1.488 (37.8)
	R	1.886 (47.9)	1	0.138 ± 0.008 (3.5 ± 0.2)	0.591 ± 0.02 (15 ± 0.5)	1.925 (48.9)	0.638 (16.2)	-	0.219 (5.55)	1.488 (37.8)

* For PL and PLS, add 0.098 in (2.5 mm) to d and I2 and 0.197 in (5 mm) to C1.

General Information

MATERIALS EXPERT

For 50 years and as a market leader, EXXELIA's comprehensive knowledge of the materials properties and performances have enabled us to design capacitors in Porcelain, NPO, BX, 2C1, BP, X7R and –2200ppm/°C ceramics.

CUSTOM DESIGNS

Our catalog products don't meet your application?

Based on the valuable experience accumulated over the design of 2,000+ specific ceramic capacitors, you can trust EXXELIA to define a qualitative custom solution in a time effective manner.

NO OBSOLESCENCE

Choosing a standard or custom EXXELIA product means you won't have to worry about obsolescence.

TYPICAL APPLICATIONS

- Aerospace & Defense: cockpit panels, flight control, radio systems, missile guidance systems...
- Space: military and commercial satellites, launcher...
- Medical: MRI, external defibrillators, implantable devices...
- Telecommunications: base stations...
- Oil and gas: drilling tools, MWD, LWD, wellheads...

ISO 9001 AND AS9100C

Quality is at the core of Exxelia's corporate culture. Each sites has its own certifications.

CERTIFICATIONS

Capacitors manufactured by EXXELIA comply with American and European standards and meet the requirements of many international standards.

For Space qualified parts (ESA QPL), please refer to our catalog «Ceramic capacitors for Space applications».

QUALITY & RELIABILITY

EXXELIA is committed to design and manufacture high quality and reliability products. The test cycles reproducing the most adverse operating conditions over extended periods (up to 10 000 hours) have logged to date well over 5.10⁹ hours/°C/component.

Failure rate data can be provided upon request.

CONFLICT MINERALS

EXXELIA is committed to an approach based on «Conflict Minerals Compliance». This US SEC rule demands complete traceability and a control mechanism for the mineral procurement chain, encouraging importers to buy only «certified» ore.

We have discontinued relations with suppliers that procure from the Democratic Republic of the Congo or an adjoining country.

ENVIRONMENT

EXXELIA is committed to applying a robust environmental policy, from product design through to shipment. To control its environmental footprint and reconcile this with the company's functional imperatives, our environmental policy provides for the reduction or elimination of hazardous substances. We also focus on compliance with European Union directives and regulations, notably REACH and RoHS.

RoHS COMPLIANCY

SMD CAPACITORS

The capacitor terminations are generally protected by a nickel barrier formed by electrolytic deposit. This barrier gives chip capacitors leaching performance far exceeding the requirements of all applicable standards. The nickel barrier guarantees a minimum resistance to soldering heat for a period of 1 minute at 260°C in a tin-lead (60/40) or tin-lead-silver (62/36/2) bath without noticeable alteration to the solderability. It also allows repeated soldering-unsoldering and the longer soldering times required by reflow techniques.

However nickel barrier amplifies thermal shock and is not recommended for chip sizes equal or greater than CNC Y (30 30) - (C 282 to C 288 - CNC 80 to CNC 94).

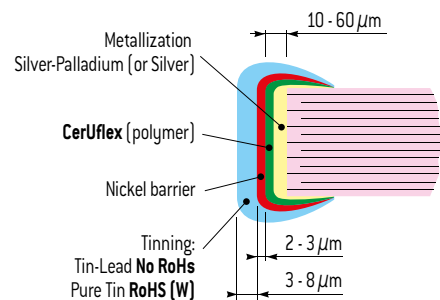















LEADED COMPONENTS

As well as for SMD products, leaded capacitors ranges can also be RoHS. These products, which are characterized by the suffix «W» added to the commercial type, are naturally compatible with the soldering alloys used in RoHS mounting technology. The connections coating is generally an alloy SnAg (with a maximum of 4% Ag). However, on a few products that EXXELIA will precise on request, the coating is pure silver.

Selection Guide

Main Characteristic	Model	Size	Dielectric	Voltage	Capacitance	Temperature	Coating					Leads				Mounting		Main Applications	Page	
							Uncoated	Varnished	Conformal coated	Molded	Self-protected	DIL	Ribbon	Axial	Radial	SMD	Through hole			
STANDARD	CEC / CNC SERIES Low and Medium Voltage Chips Capacitors	0402 to 3040	NPO BX to 2C1 X7R	10V to 1,000V	1pF to 12μF	-55°C to +125°C	•											Precision, stability, decoupling	22	
	NON MAGNETIC CHIPS SERIES Low and Medium Voltage Chips Capacitors	0505 to 2220	NPO X7R	50V to 500V	10pF to 1μF	-55°C to +125°C	•											Precision, stability, decoupling	26	
	OP SERIES Open Mode Chips Capacitors	0805 to 2220	NPO X7R	10V to 100V	1pF to 4.7μF	-55°C to +125°C	•											Precision, stability, decoupling, Significantly reduce risk of short circuit	28	
	CER / CNR SERIES Low Inductance Chips Capacitors	0306 to 0612	NPO X7R	16V to 100V	1pF to 270nF	-55°C to +125°C	•												Decoupling, low ESL, medical embedded	30
	C3N / C4N / C3E / C4E SERIES Capacitors Arrays	-	NPO X7R	25V to 200V	4.7pF to 33nF	-55°C to +125°C	•												Medical embedded, miniaturisation	32
	30 S4 SERIES Safety Capacitors	-	NPO X7R	40V to 100V	470pF to 820nF	-55°C to +125°C	•				•								Railway	33
	TCE / TCX / TCN / TXR MOLDED SERIES Radial Molded Capacitors	-	NPO BX to 2C1 X7R	25V to 500V	1pF to 4.7μF	-55°C to +125°C			•										Precision, stability, decoupling	34
	LA SERIES Radial Molded Capacitors	-	NPO Temp. coeff.	25V to 63V	1pF to 680nF	-55°C to +125°C				•									Decoupling	36
	TCE / TCX / TCN / TXR AXIAL SERIES Axial Molded Capacitors	-	NPO BX - 2C1 X7R	25V to 500V	1pF to 3.9μF	-55°C to +125°C				•									Precision, stability, decoupling	38
	TCE / TCX / TCN / TXR CONFORMAL COATED SERIES Radial Dipped Capacitors	-	NPO BX - 2C1 X7R	25V to 500V	1pF to 6.8μF	-55°C to +125°C			•										Precision, stability, decoupling	40
	NON MAGNETIC CONFORMAL COATED SERIES Radial Dipped Capacitors	-	NPO X7R	63V to 500V	180pF to 1μF	-55°C to +125°C			•										Precision, stability, decoupling	42
	CK SERIES Radial Molded Capacitors	-	BX	25V to 250V	10pF to 1μF	-55°C to +125°C				•									Decoupling	44
HIGH VOLTAGE	C Series High voltage chips Capacitors	1812 to 16080	NPO C4xx to X7R	200V to 10kV	10pF to 39μF	-55°C to +125°C	•												51	
	TCL / TCK Series High voltage Molded & Varnished leaded Capacitors	-	NPO C4xx X7R	200V to 10kV	10pF to 39μF	-55°C to +125°C			•										54	
	TCF Series High voltage Conformal coated leaded Capacitors	-	NPO C4xx X7R	200V to 10kV	10pF to 39μF	-55°C to +125°C				•									57	
	TKD Series High voltage Conformal coated leaded Capacitors	-	NPO C4xx X7R	200V to 10kV	10pF to 39μF	-55°C to +125°C				•									60	
	CS Series High voltage Stacked Capacitors	2220 to 16080	NPO C4xx X7R	1kV to 10kV	220pF to 15μF	-55°C to +125°C	•	•			•	•							62	
																		Power supply, voltage multiplier, radars. • aerospace • space • defence • railways		

Selection Guide

Main Characteristic	Model	Size range	Dielectric	Voltage range	Capacitance range	Temperature range	Coating					Leads				Mounting		Main Applications	Page
							Uncoated	Varnished	Conformal coated	Molded	Self protected	DIL	Ribbon	Axial	Radial	SMD	Through hole		
HIGH CAPACITANCE	R SERIES (CHIPS) High Capacitance Chips Capacitors 	2225 to 45107	X7R	50V to 500V	47nF to 27µF	-55°C to +125°C	•									•		Switch Mode Power Supply, filtering, smoothing, decoupling.	73
	R SERIES (LEADED) Radial Leaded Conformal Coated Capacitors 	-	X7R	50V to 500V	47nF to 27µF	-55°C to +125°C			•							•			77
	TEF SERIES Radial Leaded Conformal Coated Capacitors 	-	NPO	63V to 500V	10nF to 680nF	-55°C to +125°C			•							•			80
	SV / SC SERIES High Capacitance Stacked Capacitors 	2225 to 125205	X7R	50V to 500V	47nF to 390µF	-55°C to +125°C	•	•			•	•				•	•		81
	CNC3X SERIES High Capacitance Stacked Capacitors 	2220 to 4040	X7R	16V to 25V	1.2µF to 68µF	-55°C to +125°C	•	•			•					•	•		88
	CEC5X SERIES High Capacitance Stacked Capacitors 	3033 to 80150	NPO	63V to 500V	10nF to 6.8µF	-55°C to +125°C	•	•			•					•	•		90
	TEP / TEV SERIES High Capacitance Stacked Capacitors 	-	NPO	63V to 500V	10nF to 6.8µF	-55°C to +125°C		•								•	•		93
TCN8X SERIES High Capacitance Molded Stacked Capacitors 	-	X7R	63V to 500V	0.47µF to 120µF	-55°C to +125°C				•						•	•		95	
HIGH TEMPERATURE	CE / CN SERIES High Temperature Chips Capacitors 	0402 to 3040	NPO to X7R	16V to 100V	1pF to 8.2µF	-55°C to +250°C	•									•			100
	SCT SERIES High Temperature Stacked Capacitors 	2225 to 125205	X7R	50V to 500V	47nF to 390µF	-55°C to +215°C	•	•			•					•	•		102
	TCE / TCN MOLDED SERIES HT High Temperature Molded Capacitors 	-	NPO to X7R	16V to 100V	1pF to 10µF	-55°C to +220°C				•						•	•		107
	TCE / TCN SELF-PROTECTED SERIES High Temperature Self-Protected Capacitors 	-	NPO to X7R	25V to 500V	10pF to 3.9µF	-55°C to +250°C					•					•	•		109
	TCH SERIES High Temperature High Voltage Capacitors 	-	NPO to X7R	200V to 10kV	10pF to 15µF	-55°C to +250°C		•								•	•		111
FEED-THRU	TBC SERIES Discoidal Capacitors 	-	NPO to X7R	25V to 1kV	10pF to 12µF	-55°C to +125°C	•									•		Very low ESL	115
	BPM SERIES Planar Array 	-	X7R	25V to 200V	330pF to 68nF	-55°C to +125°C	•									•		Very low ESL, miniaturisation	117

Selection Guide

Main Characteristic	Model	Size range	Dielectric	Voltage range	Capacitance range	Temperature range	Coating					Leads				Mounting		Main Applications	Page
							Uncoated	Varnished	Conformal coated	Molded	Self protected	DIL	Ribbon	Axial	Radial	SMD	Through hole		
HIGH Q	XBL SERIES Broadband	0402	X7R	16V	100nF	-55°C to +125°C	•											DC Blocking, Coupling, Bypassing	138
	UBL SERIES Broadband	0402	X7R	16V	100nF	-55°C to +125°C	•												140
	UBZ SERIES Broadband	0201	X5R X6T	10V	100nF	-55°C to +105°C	•												142
	CH SERIES Classic HiQ	0505 1111	P100	50V to 1.5kV	0.1pF to 1nF	-55°C to +175°C	•				•		•	•				Cellular base station amplifier, MRI.	144
	SH SERIES Super HiQ	0402 to 1210	NPO	25V to 1.5kV	0.2pF to 1nF	-55°C to +150°C	•				•		•	•				Cellular base station equipment	147
	SHD / SHR SERIES Reverse Geometry	0709 0711	NPO	500V	0.5pF to 100pF	-55°C to +175°C	•							•				Broadband Point to point/ multi-point radios RF generators	150
	NHB SERIES High Self Resonant Frequency	1111	NPO	500V	0.3pF to 100pF	-55°C to +175°C	•							•					152
	CP SERIES High Power	2225 4040	P100	200V to 7kV	1pF to 10nF	-55°C to +125°C	•	•			•	•	•	•	•			RF power amplifier Plasma chamber MRI coils	154
	CL SERIES High Power	2225 to 7065	NPO	200V to 7kV	1pF to 10nF	-55°C to +125°C	•	•			•	•	•	•	•			RF power amplifier Plasma chamber MRI coils	158

ADDITIONAL AVAILABLE RANGES (consult our website)

STANDARD	TCE1X Series	-	NPO	63V to 100V	0.5pF to 10nF	-55°C to +125°C				•								Precision, stability, decoupling	-	
	TCN19 Series	-	2C1	63V to 250V	10pF to 1µF	-55°C to +125°C				•								Decoupling	-	
	TCN3X Series	-	2C1	50V to 100V	100pF to 1,8µF	-55°C to +125°C				•									-	
	LA6 Series	-	2C1	25V to 63V	100pF to 1µF	-55°C to +125°C				•									-	
HIGH VOLT.	H Series	0805 to 6560	NPO X7R	1kV to 10kV	2pF to 390nF	-55°C to +125°C	•	•										Power supply, voltage multiplier, radars.	-	
HIGH CAPACITANCE	CNC5X Series	3033 to 80150	X7R	63V to 500V	0.1µF to 180µF	-55°C to +125°C	•	•		•								Switch Mode Power Supply, filtering, smoothing, decoupling. • aerospace • space • defence	-	
	CNC8X Series (chips)	3033 to 33110	X7R	63V to 400V	47nF to 27µF	-55°C to +125°C	•												-	
	CNC8X Series (DIL)	3333 to 80150	X7R	63V to 400V	47nF to 180µF	-55°C to +125°C	•	•		•									-	
	TCP / TCV8X Series	3333 to 80150	X7R	63V to 400V	47nF to 180µF	-55°C to +125°C		•												-
	TCP / TCV5X Series	3033 to 80150	X7R	63V to 500V	0.1µF to 180µF	-55°C to +125°C		•												-
	TCF Series	-	X7R	63V to 500V	0.1µF to 18µF	-55°C to +125°C			•											-
HIGH TEMP.	CNC25X Series	3033 to 5550	X7R	50V	1µF to 33µF	-55°C to +200°C	•	•		•								Oil drilling, motor control, braking systems.	-	
HIGH Q	CNW Series	-	X7R	100V to 300V	10nF to 1µF	-55°C to +125°C	•					•	•					Power amplifier	-	
	SPT519 / CAW CEW Series	-	NPO	100V to 300V	10nF to 1µF	-55°C to +125°C	•	•											-	

Ceramic Capacitors Technology

MLCC STRUCTURE

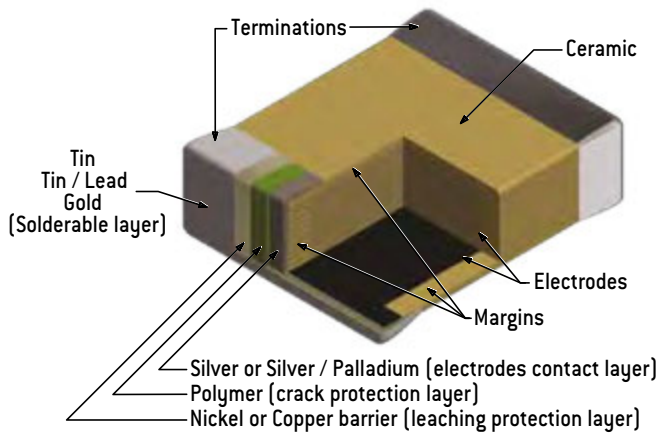

EQUIVALENT CIRCUIT

Capacitor is a complex component combining resistive, inductive and capacitive phenomena. A simplified schematic for the equivalent circuit is:

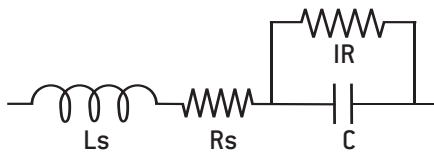

DIELECTRIC CHARACTERISTICS

Insulation Resistance (IR) is the resistance measured under DC voltage across the terminals of the capacitor and consists principally of the parallel resistance shown in the equivalent circuit. As capacitance values and hence the area of dielectric increases, the IR decreases and hence the product (C x IR) is often specified in $\Omega \cdot F$ or $M\Omega \cdot \mu F$.

The Equivalent Series Resistance (ESR) is the sum of the resistive terms which generate heating when capacitor is used under AC voltage at a given frequency (f).

Dissipation factor (DF) is the ration of the apparent power input will turn to heat in the capacitor:

$$DF = 2\pi f C ESR$$

When a capacitor works under AC voltage, **heat power loss (P)**, expressed in Watt, is equal to:

$$P = 2\pi f C V_{rms}^2 DF$$

The series inductance (Ls) is due to the currents running through the electrodes. It can distort the operation of the capacitor at high frequency where the **impedance (Z)** is given as:

$$Z = R_s + j (L_s \cdot \omega - 1 / (C \cdot \omega)) \text{ with } \omega = 2\pi f$$

When frequency rises, the capacitive component of capacitors is gradually canceled up to the resonance frequency, where :

$$Z = R_s \text{ and } L_s C \cdot \omega^2 = 1$$

Above this frequency the capacitor behaves like an inductor.

	P100	NPO	N2200 (C4xx)	BX	2C1	X7R
Dielectric material	Porcelain	Magnesium titanate or Neodymium baryum titanate	Barium zirconate titanate	Baryum titanate (BaTiO ₃)		
Dielectric constant	15 – 18	20 – 85	450	2,000 – 5,000		
Electrode technology	PME (Precious Metal Electrodes): Ag/Pd					
Capacitance variation between –55°C and +125°C without DC voltage	(100 ± 30)ppm/°C	(0 ± 30)ppm/°C	(–2,200 ± 500) ppm/°C	± 15%	± 20%	± 15%
Capacitance variation between –55°C and +125°C with DC rated voltage			0 -15%	15% –25%	20% –30%	Not applicable
Piezo-electric effect	None		None	Yes		
Dielectric absorption	None		Few %	Few %		
Thermal shock sensitive	+		+	++		

Ceramic Capacitors Technology

MANUFACTURING STEPS

SLIP CASTING



A slurry, a mix of ceramic powder, binder and solvents, is poured onto conveyor belt inside a drying oven, resulting in a dry ceramic sheet.

ELECTRODE SCREEN PRINTING

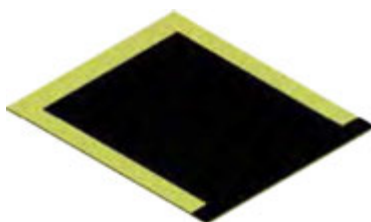

The electrode ink, made from a metal powder mixed with solvents, is printed onto the ceramic sheets using a screen printing process.

STACKING

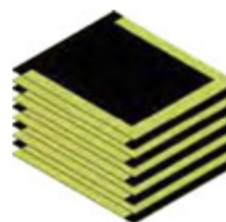

The sheets with electrode printed are stacked to create a multilayer structure.

PRESSING

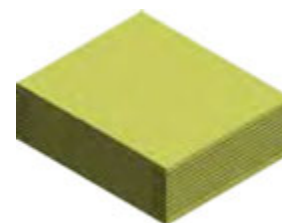

Pressure is applied to the stack to fuse all the separate layers, this created a monolithic structure.

SINTERING

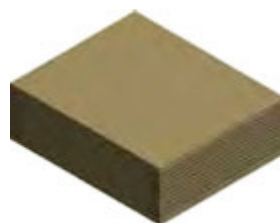

The parts are sintered in an oven with a precise temperature profile which is very important to the characteristics of the capacitors.

TERMINATIONS

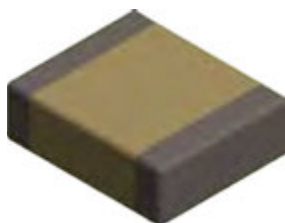

Each terminal of the capacitor is dipped in the termination ink, mix of metal powder, solvents and glass frit and the parts are fired in an oven.

TERMINATIONS PLATING

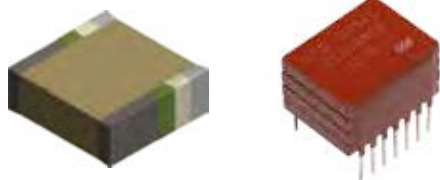

Stacking + leads soldering + encapsulation
[see pages 10-11]

FINAL TESTING

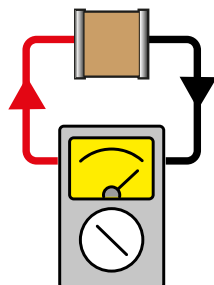

PACKAGING



User Guide

SMD TERMINATIONS

NON RoHS COMPLIANT	Code	RoHS COMPLIANT	Code	Recommended mounting process							Storage [months]*
				Magnetic	Epoxy bonding	Iron soldering	Wave soldering	Vapor phase soldering	Infrared soldering	Wire bonding	
Ag	Q	Ag	QW / P	No	•	•	•	•			18
Ag/Pd/Pt	-	Ag/Pd/Pt	W / A	No	•	•	•				24
Ag + Ni + dipped Sn/Pb 60/40	T**	-	-	No		•	•	•	•		24
Ag/Pd/Pt + dipped Sn/Pb 60/40	H	Ag/Pd/Pt + dipped Sn	HW	No		•					24
Ag + Ni + electrolytic Sn/Pb 95/5	C	Ag + Ni + electrolytic Sn	CW / S	Yes		•	•	•	•		18
Ag + Ni + electrolytic Sn/Pb 60/40	D	-	-	Yes		•	•	•	•		18
-	-	Ag + Cu + electrolytic Sn	C***	No		•	•	•	•		18
Ag + Ni + dipped Sn/Pb 60/40	E	Ag + Ni + electrolytic Sn	EW	Yes		•	•				24
Ag + Ni + Au	G	Ag + Ni + Au	GW	Yes	•	•	•	•	•	•	36
Ag + Polymer + Ni + Sn/Pb 95/5	YC	Ag + Polymer + Ni + Sn	YCW	Yes		•	•	•	•		18
Ag + Polymer + Ni + Sn/Pb 60/40	YD	-	-	Yes		•	•	•	•		18
Ag + Polymer + Ni + Au	YG	Ag + Polymer + Ni + Au	YGW	Yes	•	•	•	•	•	•	36

Nickel (Ni) or Copper (Cu) barriers amplify thermal shock and are not recommended for chip sizes larger than 3030.

* Storage must be in a dry environment at a temperature of 20°C with a relative humidity below 50%, or preferably in a package enclosing a desiccant.

** Maintenance only.

*** Non magnetic chips series only.

SMD ENVIRONMENTAL TESTS

Ceramic chip capacitors for SMD are designed to meet test requirements of **CECC 32100** and **NF C 93133** standards as specified below in compliance with **NF C 20700** and **IEC 68** standards:

- Solderability: **NF C 20758**, 260°C, bath 62/36/2.
- Adherence: 5N force.
- Vibration fatigue test: **NF C 20706**, 20 g, 10 Hz to 2,000 Hz, 12 cycles of 20 minutes each.
- Rapid temperature change: **NF C 20714**, -55°C to + 125°C, 5 cycles.
- Combined climatic test: **IEC 68-2-38**.
- Damp heat: **NF C 20703**, 93 %, H.R., 40°C.
- Endurance test: 1,000 hours, 1.5 U_{RC}, 125°C.

STORAGE OF CHIP CAPACITORS

TINNED OR NON TINNED CHIP CAPACITORS

Storage must be in a dry environment at a temperature of 20°C with a relative humidity below 50 %, or preferably in a packaging enclosing a desiccant.

STORAGE IN INDUSTRIAL ENVIRONMENT:

- 2 years for tin dipped chip capacitors,
- 18 months for tin electroplated chip capacitors,
- 2 years for non tinned chip capacitors,
- 3 years for gold plated chip capacitors.

STORAGE IN CONTROLLED NEUTRAL NITROGEN ENVIRONMENT:

- 4 years for tin dipped or electroplated chip capacitors,
- 4 years for non tinned chip capacitors,
- 5 years for gold plated chip capacitors.

Storage duration should be considered from delivery date and not from batch manufacture date. The tests carried out at final acceptance stage [solderability, susceptibility to solder heat] enable to assess the compatibility to surface mounting of the chips.

User Guide

LEAD STYLES

SURFACE MOUNTING

DIL LEADS

P style



PL style



L style



J style

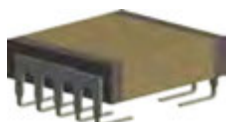

RIBBON LEADS

Micro-strip (type 1)
Short Micro-strip (type 1S)

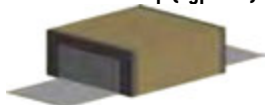

Axial (Type 2)



Radial (Type 3)



R style

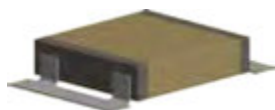

RX style

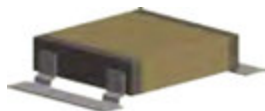

RJ style

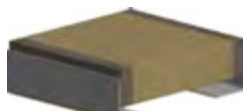

Please contact Exxelia sales for any lead configuration not shown.

TROUGH-HOLE MOUNTING

AXIAL AND RADIAL

Radial leads (Type 6)



Radial leads (4 leads)



Axial leads (Type 7)



DIL leads: N style

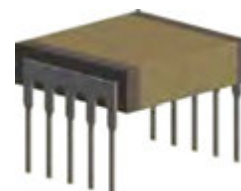

ENCAPSULATION STYLES

Ceramic encapsulation
(selfprotected)



Varnish



Conformal coating



Molding



User Guide

SOLDERING ADVICES FOR REFLOW SOLDERING

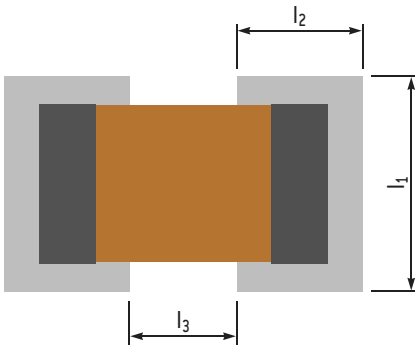

Large chips above size 2225 are not recommended to be mounted on epoxy board due to thermal expansion coefficient mismatch between ceramic capacitor and epoxy. Where larger sizes are required, it is recommended to use components with ribbon or other adapted leads so as to absorb thermo-mechanical strains.

Dimensions in inches (in mm)	Reflow soldering						Wave soldering					
	l ₁		l ₂		l ₃		l ₁		l ₂		l ₃	
0402	0.043	(1.1)	0.035	(0.9)	0.012	(0.3)	0.043	(1.1)	0.047	(1.2)	0.012	(0.3)
0403	0.055	(1.4)	0.035	(0.9)	0.012	(0.3)	0.055	(1.4)	0.047	(1.2)	0.012	(0.3)
0504	0.063	(1.6)	0.051	(1.3)	0.016	(0.4)	0.063	(1.6)	0.063	(1.6)	0.016	(0.4)
0603	0.055	(1.4)	0.059	(1.5)	0.02	(0.5)	0.055	(1.4)	0.071	(1.8)	0.02	(0.5)
0805	0.073	(1.85)	0.065	(1.65)	0.024	(0.6)	0.073	(1.85)	0.077	(1.95)	0.024	(0.6)
0907	0.094	(2.4)	0.065	(1.65)	0.035	(0.9)	0.094	(2.4)	0.077	(1.95)	0.035	(0.9)
1005	0.073	(1.85)	0.067	(1.7)	0.039	(1)	0.073	(1.85)	0.079	(2)	0.039	(1)
1206	0.083	(2.1)	0.067	(1.7)	0.059	(1.5)	0.083	(2.1)	0.079	(2)	0.059	(1.5)
1210	0.118	(3)	0.069	(1.75)	0.059	(1.5)	0.118	(3)	0.081	(2.05)	0.059	(1.5)
1605	0.073	(1.85)	0.071	(1.8)	0.087	(2.2)	0.073	(1.85)	0.083	(2.1)	0.087	(2.2)
1806	0.087	(2.2)	0.073	(1.85)	0.102	(2.6)	0.087	(2.2)	0.085	(2.15)	0.102	(2.6)
1812	0.152	(3.85)	0.073	(1.85)	0.102	(2.6)	0.152	(3.85)	0.085	(2.15)	0.102	(2.6)
1825	0.281	(7.15)	0.073	(1.85)	0.102	(2.6)	0.281	(7.15)	0.085	(2.15)	0.102	(2.6)
2210	0.13	(3.3)	0.079	(2)	0.146	(3.7)	0.13	(3.3)	0.091	(2.3)	0.146	(3.7)
2220	0.228	(5.8)	0.079	(2)	0.146	(3.7)	0.228	(5.8)	0.091	(2.3)	0.146	(3.7)
2225	0.281	(7.15)	0.079	(2)	0.146	(3.7)	0.281	(7.15)	0.091	(2.3)	0.146	(3.7)

RECOMMENDED FOOTPRINT FOR SMD CAPACITORS

Ceramic is by nature a material which is sensitive both thermally and mechanically. Stresses caused by the physical and thermal properties of the capacitors, substrates and solders are attenuated by the leads.

Wave soldering is unsuitable for sizes larger than 2220 and for the higher ends of capacitance ranges due to possible thermal shock (capacitance values given upon request).

Infrared and vapor phase reflow, are preferred for high reliability applications as inherent thermo-mechanical strains are lower than those inherent to wave soldering.

Whatever the soldering process is, it is highly recommended to apply a thermal cycle, see hereafter our recommended soldering profile:

RECOMMENDED VAPOR PHASE REFLOW PROFILE

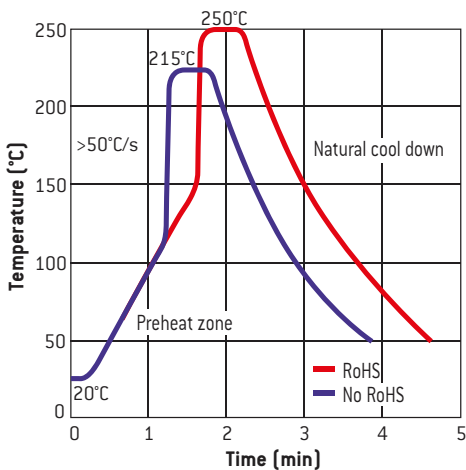

RECOMMENDED IR REFLOW PROFIL

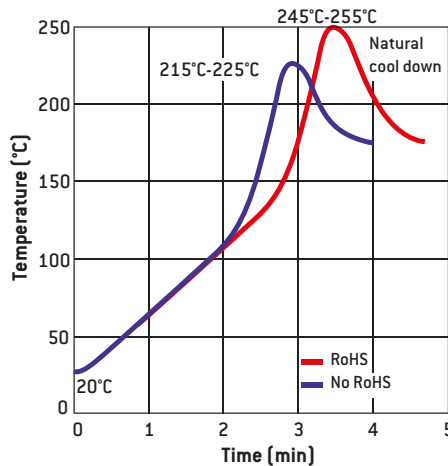

RECOMMENDED WAVE SOLDERING PROFILE

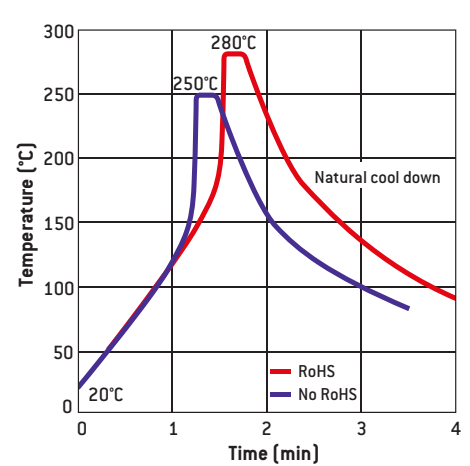

SOLDERING ADVICES FOR IRON SOLDERING

Attachment with a soldering iron is discouraged due to ceramic brittleness and the process control limitations. In the event that a soldering iron must be used, the following precautions should be observed:

- Use a substrate with chip footprints big enough to allow putting side by side one end of the capacitor and the iron tip without any contact between this tip and the component,
- place the capacitor on this footprint,

- heat the substrate until the capacitor's temperature reaches 150°C minimum (preheating step, maximum 1°C per second),
- place the hot iron tip (a flat tip is preferred) on the footprint **without touching the capacitor**. Use a regulated iron with a 30 watts maximum power. The recommended temperature of the iron is 270 ± 10°C. The temperature gap between the capacitor and the iron tip must not exceed 120°C,

User Guide

- leave the tip on the footprint for a few seconds in order to increase locally the footprint's temperature,
- use a cored wire solder and put it down on the iron tip. In a preferred way use Sn/Pb/Ag 62/36/2 alloy,
- wait until the solder fillet is formed on the capacitor's termination,
- take away iron and wire solder,

- wait a few minutes so that the substrate and capacitor come back down to the preheating temperature,
- solder the second termination using the same procedure as the first,
- let the soldered component cool down slowly to avoid any thermal shock.

PACKAGING

TAPE AND REEL

The films used on the reels correspond to standard IEC 60286-3. Films are delivered on reels in compliance with document IEC 286-3 dated 1991.

Minimum quantity is 250 chips.

Maximum quantities per reel are as follows:

- Super 8 reel - Ø 180: 2,500 chips.
- Super 8 reel - Ø 330: 10,000 chips.
- Super 12 reel - Ø 180: 1,000 chips.

Reel marking complies with CECC 32100 standard:

- Model.
- Rated capacitance.
- Capacitance tolerance.
- Rated voltage.
- Batch number.

TRAY PACKAGES

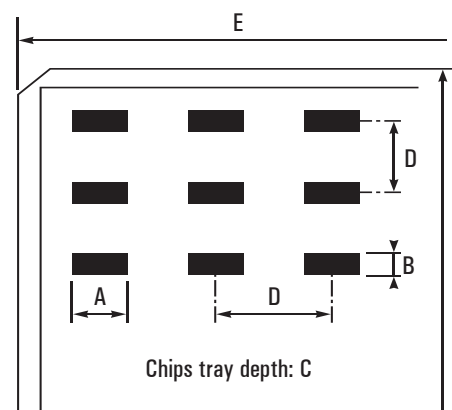

DIMENSIONAL CHARACTERISTICS OF CHIPS TRAY PACKAGES

Sizes	Nr. of chips/ package	Oriented chips	Dimensions in inches (in mm)				
			A	B	C	D	E
0402	100	No	0 0.112 [0 3.02]		0.065 [1.65]	0.167 [4.24]	2 [50.8]
0403	100	No	0 0.112 [0 3.02]		0.065 [1.65]	0.167 [4.24]	2 [50.8]
0504	100	Yes	0.059 [1.5]	0.045 [1.14]	0.035 [0.89]	0.167 [4.24]	2 [50.8]
0603	340	Yes	0.1 [2.54]	0.06 [1.52]	0.045 [1.14]	0.167 [4.24]	2 [50.8]
0805	100	Yes	0.1 [2.54]	0.06 [1.52]	0.045 [1.14]	0.167 [4.24]	2 [50.8]
1206	100	No	0.14 [3.56]	0.14 [3.56]	0.06 [1.52]	0.167 [4.24]	2 [50.8]
1210	100	Yes	0.14 [3.56]	0.14 [3.56]	0.06 [1.52]	0.167 [4.24]	2 [50.8]
1812	100	No	0.25 [6.35]	0.25 [6.35]	0.13 [3.3]	0.345 [8.76]	4 [101.6]
	25	Yes	0.24 [6.1]	0.265 [6.73]	0.07 [1.78]	0.345 [8.76]	2 [50.8]
2220	100	Yes	0.25 [6.35]	0.25 [6.35]	0.13 [3.3]	0.345 [8.76]	4 [101.6]
	25	Yes	0.24 [6.1]	0.265 [6.73]	0.07 [1.78]	0.345 [8.76]	2 [50.8]

HIGH Q CAPACITORS TAPE AND REEL PACKAGING SPECIFICATIONS

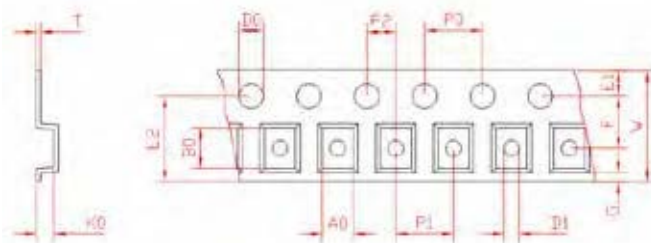

Sizes	Type [1]	W±0.3 inches (mm)	F ±0.05 inches (mm)	P1 ±0.1 inches (mm)	T max. inches (mm)	Reel Size inches (mm)	Quantity per Reel
A [0505]	H	0,315 [8]	0,138 [3.5]	0,157 [4]	0,010 [0,25]	7,087 [180]	3'000
A [0505]	V	0,315 [8]	0,138 [3.5]	0,157 [4]	0,010 [0,25]	7,087 [180]	3'000
S [0603]	H	0,315 [8]	0,138 [3.5]	0,157 [4]	0,016 [0,4]	7,087 [180]	4'000
F [0805]	H	0,315 [8]	0,138 [3.5]	0,157 [4]	0,016 [0,4]	7,087 [180]	4'000
B [1111]	H	0,315 [8]	0,138 [3.5]	0,157 [4]	0,012 [0,3]	7,087 [180]	1'000
B [1111]	V	0,315 [8]	0,138 [3.5]	0,157 [4]	0,010 [0,25]	7,087 [180]	1'000
X [2225]	H	0,472 [12]	0,138 [5.5]	0,472 [12]	0,018 [0,45]	12,992 [330]	500
E [4040]	H	0,945 [24]	0,453±0,004 [11.5±0.1]	0,630 [16]	0,018 [0,45]	12,992 [330]	700
E [4040]	V	1,260 [32]	0,559±0,004 [14.2±0.1]	0,945 [24]	0,022 [0,55]	15 [381]	350

[1]: Horizontal (H) or Vertical (V) orientation in cavities.

User Guide

EIA STANDARD CAPACITANCE VALUES

Following EIA standard, the values and multiples that are indicated in the chart below can be ordered. E48, E96 series and intermediary values are available upon request.

E6 (± 20%)	E12 (± 10%)	E24 (± 5%)
10	10	10
		11
		12
15	12	13
		15
		16
22	15	18
		20
		22
33	18	24
		27
		30
47	22	33
		36
		39
68	33	43
		47
		51
100	39	56
		62
		68
150	47	75
		82
		91

EIA CAPACITANCE CODE

The capacitance is expressed in three digit codes and in units of pico Farads (pF). The first and second digits are significant figures of the capacitance value and the third digit identifies the multiplier.

For capacitance value < 10pF, R designates a decimal point.
See examples below:

EIA code	Capacitance value		
	in pF	in nF	in μ F
2R2	2.2	0.0022	0.0000022
6R8	6.8	0.0068	0.0000068
220	22	0.022	0.000022
470	47	0.047	0.000047
181	180	0.18	0.00018
221	220	0.22	0.00022
102	1,000	1	0.001
272	2,700	2.7	0.0027
123	12,000	12	0.012
683	68,000	68	0.068
124	120,000	120	0.12
564	560,000	560	0.56
335	3,300,000	3,300	3.3
825	8,200,000	8,200	8.2
156	15,000,000	15,000	15
686	68,000,000	68,000	68
107	100,000,000	100,000	100
227	220,000,000	220,000	220

PART MARKING VOLTAGE CODES

Use the following voltage code chart for part markings:

Voltage (V)	Code	Letter code
25	250	A
40	400	B
50	500	C
63	630	D
100	101	E
200	201	G
250	251	H
400	401	K
500	501	L
1,000	102	M
2,000	202	P
3,000	302	R
4,000	402	S
5,000	502	T
7,500	752	U
10,000	103	W

PART MARKING TOLERANCE CODES

Use the following tolerance code chart for part markings:

Tolerance	Letter code
± 0.25pF	CU
± 0.5pF	DU
± 1pF	FU
± 1%	F
± 2%	G
± 5%	J
± 10%	K
± 20%	M

User Guide

RELIABILITY LEVELS

Exxelia proposes different reliability levels for the ceramic capacitors for both NPO and X7R ceramics.

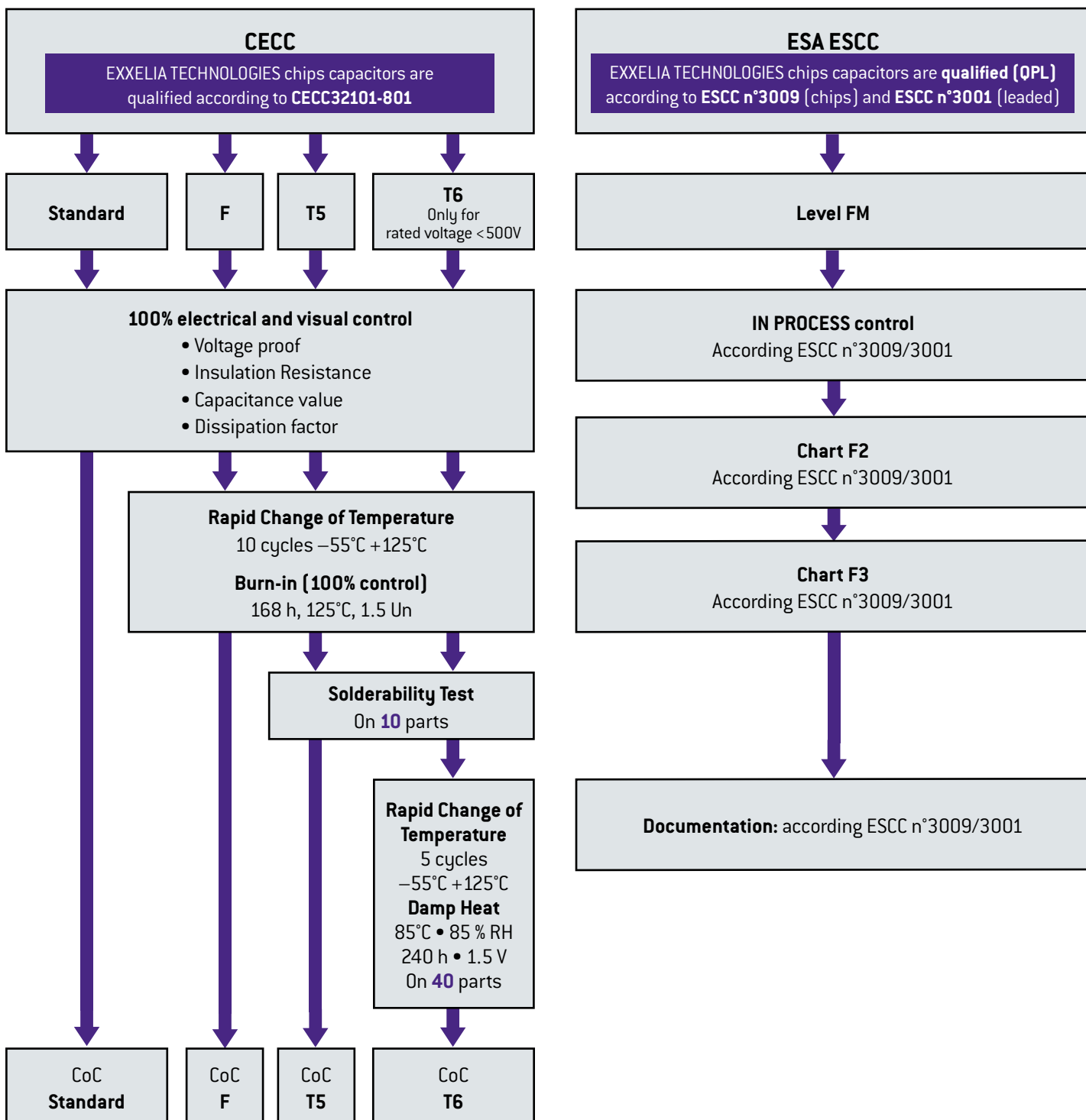

As the world's leading manufacturer of specific passive components, we stand apart through our ability to quickly evaluate the application specific engineering challenges and provide a cost-effective and efficient solutions.

For requirements that cannot be met by catalog products, we offer leading edge solutions in custom configuration: custom geometries, packaging, characteristics, all is possible thanks to our extensive experience and robust development process, while maintaining the highest level of reliability.

Where necessary, special testing is done to verify requirements, such as low dielectric absorption, ultra-high insulation resistance, low dissipation factor, stability under temperature cycling or under specified environmental conditions, etc.

HIGH CAPACITANCE

- High energy density
- Specific case sizes
- Specific shape of connections (high resistance to vibrations)



HIGH VOLTAGE

- Up to 50 kV
- Specific circular shape

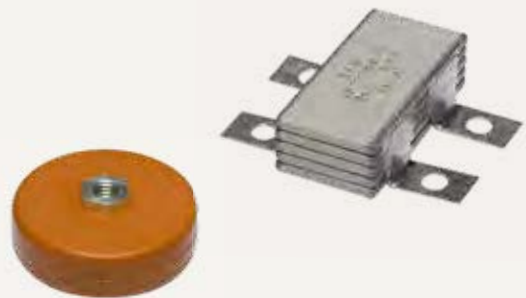

HIGH TEMPERATURE

- Up to 250°C
- Specific shape of connections
- 2,000 hours life time
- HMP soldering

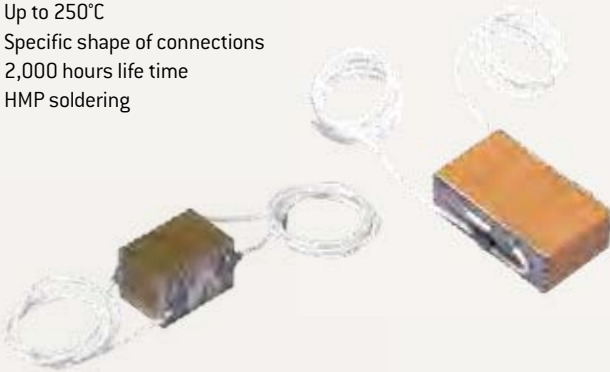

OTHERS

- Screen printed resistors
- Complex components
- Full functions available

