

Common Mode Chokes for DC/DC Embedded Applications

CMC 22 xxx 2WR Series



- Based on EXXELIA's «SESI22 Planar Technology»
- Low-profile SMD package (2 x 4 pins)
- Applied standards: MIL-STD-202, ECSS-Q-70-02, D0-160
- **eesa** ESCC 3201/010 version upon request
- RMS current range: from 1.9 A to 14.3 A for 40°C heating above 25°C
- Excellent impedance attenuation > 100 Ω from 300 kHz to 35 MHz
- Dielectric strength test up to 500 V (50 Hz - 1 min)
- Materials meet UL94-V0 rating
- Thermal index according to IEC85: H (180°C)
- Operating/storage temperature range: -55°C to +125°C
- Approximative weight: 26 grams

Electrical Data

ID Code	Inductance Value at 25°C (±40%)	Typical SRF	max. Impedance [Typical]	max. Attenuation [Z = 50Ω]	max. RMS Current for ΔT = 40°C Heating	max. R _{DC} (25°C)	Dielectric Strength (50Hz - 1min)
CMC22 60K 2WR	0.06 mH	3 MHz	1.1 kΩ	22 dB	14.3 A	5 mΩ	500 Vrms
CMC22 M14 2WR	0.14 mH	2 MHz	2.9 kΩ	30 dB	9.1 A	10 mΩ	500 Vrms
CMC22 M34 2WR	0.34 mH	1.5 MHz	9.1 kΩ	39 dB	5.8 A	20 mΩ	500 Vrms
CMC22 M74 2WR	0.74 mH	1.1 MHz	21.8 kΩ	47 dB	4.3 A	40 mΩ	500 Vrms
CMC22 1M6 2WR	1.6 mH	0.7 MHz	64.6 kΩ	56 dB	2.8 A	95 mΩ	500 Vrms
CMC22 3M3 2WR	3.3 mH	0.65 MHz	250 kΩ	68 dB	1.9 A	205 mΩ	500 Vrms

Typical Dimensions (mm, top view)

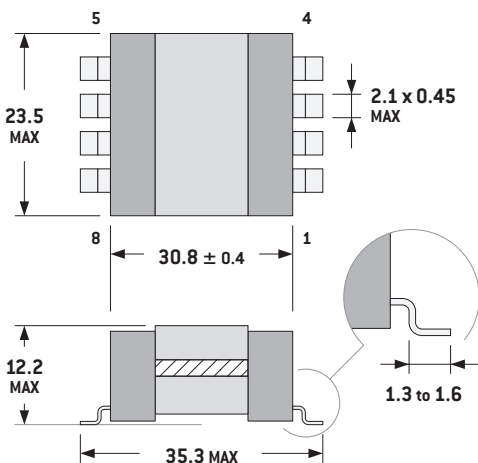

PCB Layout (suggested)

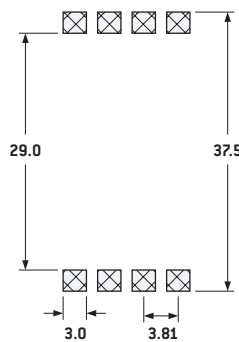

Connections (top view)

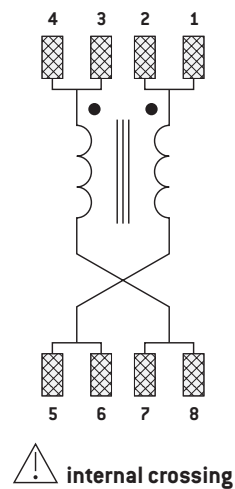

Packaging

Tape and Reel:
100 units per reel of diameter 330 mm

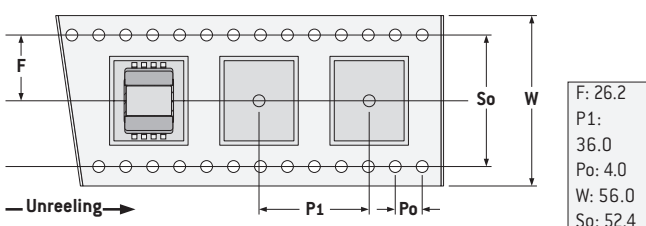

Marking

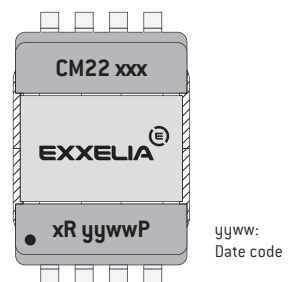

HIGH GRADE PRODUCTS

Common Mode Chokes for DC/DC Embedded Applications

CMC 22 xxx 2WR Series

Impedance

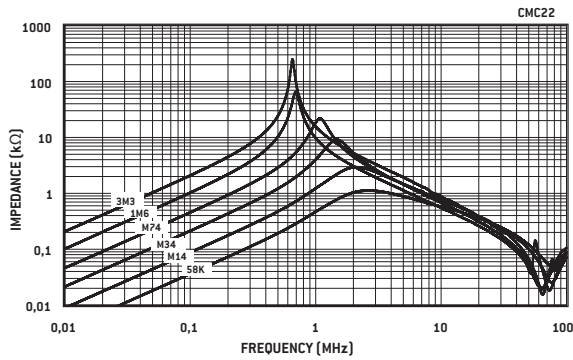

Typical values at 25°C with 1 mT at 10 kHz

Attenuation

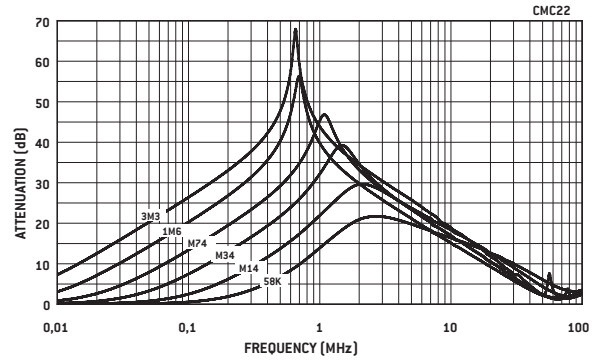

Typical values ($Z = 50 \Omega$) at 25°C with 1 mT at 10 kHz

Variation vs Temperature

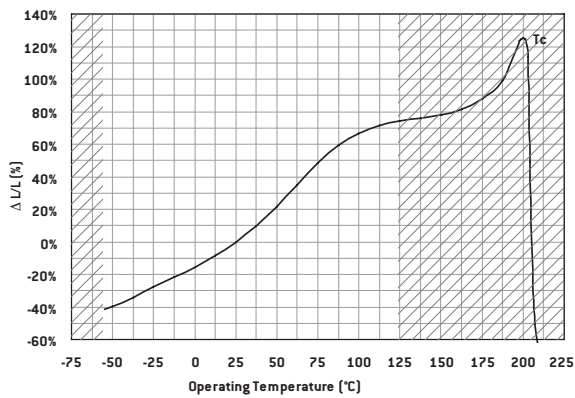

Change in inductance value (< 1 mT at 10 kHz)

Attenuation Measurement Circuit

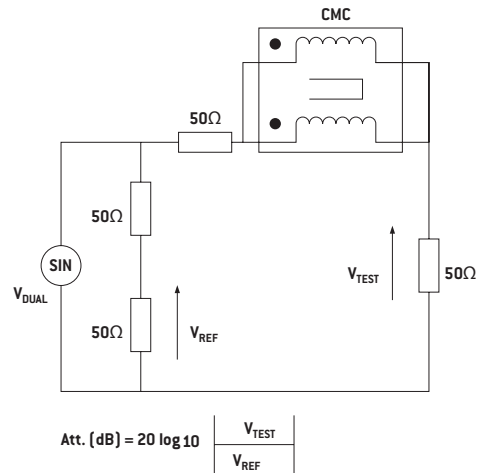

Common Mode Chokes for DC/DC Embedded Applications

CMC 22 xxx 2WR Series

Derating Curves

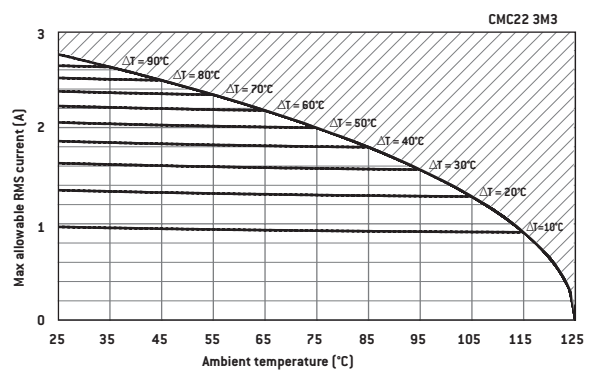
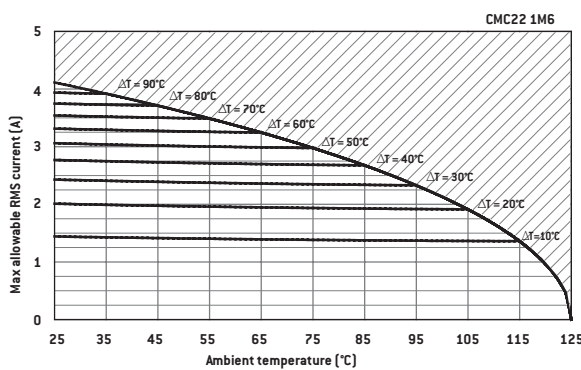
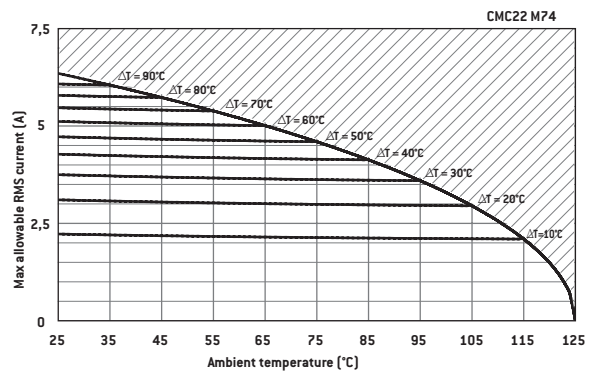
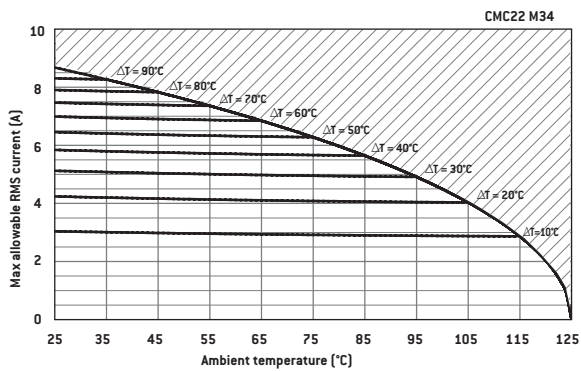
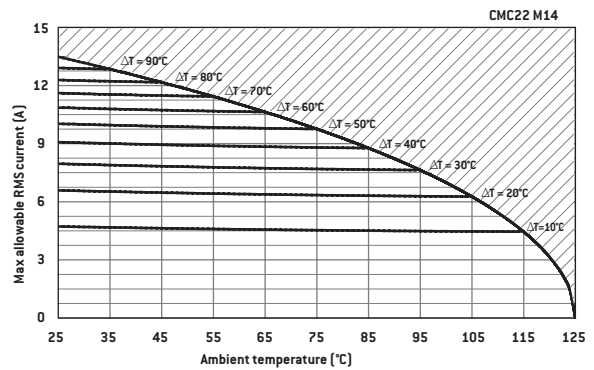
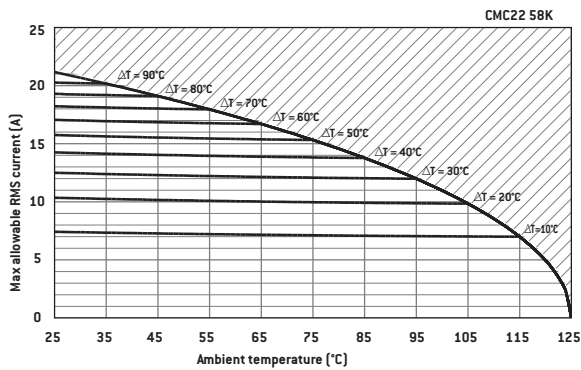

All thermal measurements under atmospheric conditions with component mounted on 1 dm² PCB without cooling device. All above graphs indicate maximum RMS current allowed through component v. ambient temperature for a defined ΔT . Maximum operating temperature is +125°C.

Example:
 CMC22 58K for application with $T_{amb} = +85^\circ\text{C}$. max. current allowed is < 14 Arms with $\Delta T < 40^\circ\text{C}$.
 If temp increase allowed in application is limited to $\Delta T < 20^\circ\text{C}$, current must be reduced to 10 Arms.

HIGH GRADE PRODUCTS

SMD Power Inductors

CMC 15WR - 18WR - 22WR



Since 2013, EXXELIA has been manufacturing Common Mode Chokes, CMC15/18/22 WR series fulfilling ESA ESCC Generic specification N° 3201 and detail specification N° 3201/010.

This qualification approval includes final production tests Chart F2, burn-in and electrical measurements Chart F3 and qualification testing Chart F4.

For procurement, different quality levels are offered:

- Final production tests Chart F2
- Burn-in and electrical measurements Chart F3
- Lot acceptance testing Chart F4 if required

Components delivered through this specification need to be processed and inspected in accordance with the EXXELIA Process Identification Document (P.I.D.).

Each component delivered is traceable to its production lot.

The terminal material and finish shall be brass, plated with 2 to 4 μm of Nickel, the finish shall be either Sn60Pb40 or Sn90Pb10.

Cross reference chart

EXXELIA Non-QPL ID Code	ESA SCC Component Part Number
CMC 15 52K 2WR	3201010 01 520
CMC 15 M11 2WR	3201010 01 111
CMC 15 M22 2WR	3201010 01 221
CMC 15 M47 2WR	3201010 01 471
CMC 15 1M0 2WR	3201010 01 102
CMC 15 2M0 2WR	3201010 01 202
CMC 15 4M0 2WR	3201010 01 402
CMC 18 60K 2WR	3201010 03 600
CMC 18 M13 2WR	3201010 03 131
CMC 18 M27 2WR	3201010 03 271
CMC 18 M54 2WR	3201010 03 541
CMC 18 1M1 2WR	3201010 03 112
CMC 18 2M4 2WR	3201010 03 242
CMC 18 4M9 2WR	3201010 03 492
CMC 22 60K 2WR	3201010 05 580
CMC 22 M14 2WR	3201010 05 141
CMC 22 M34 2WR	3201010 05 341
CMC 22 M74 2WR	3201010 05 741
CMC 22 1M6 2WR	3201010 05 162
CMC 22 3M3 2WR	3201010 05 332

3201010 0 ### y

Tolerance: $\pm 40\%$

Technical note - Appendix

CMC 15 - 18 - 22 & CMC 17 Temperature Application

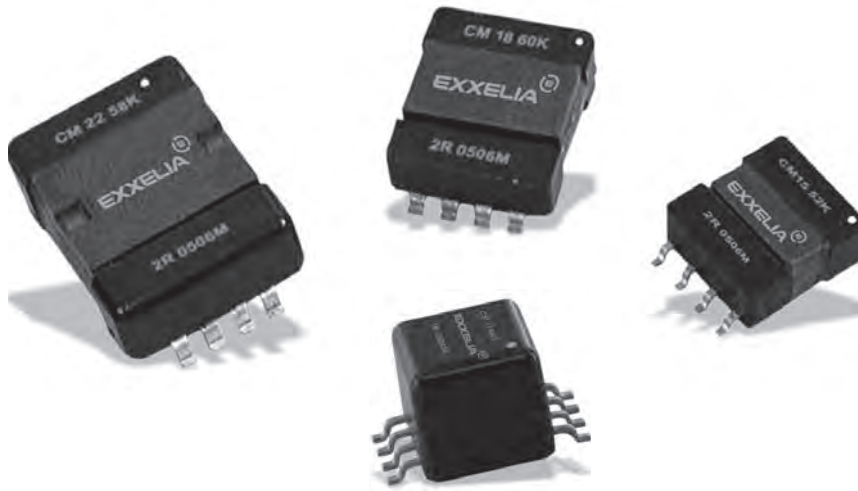

- The operating temperature announced in the datasheets takes into account maximum ambient temperature around the component +its self heating temperature in operation.
- Typical T° range is -55°C $+125^{\circ}\text{C}$ for usual embedded applications (avionics, defence, space...) in order to ensure a good ageing of the products.
- EXXELIA guarantees an extended lifetime in this operational T° range, because only high temperature class materials are used and offer sufficient safety margin: all plastic materials used are H class according to IEC85 standard (180°C during 20.000 hours) and magnetic cores show a high Curie temperature value ($T_c > 200^{\circ}\text{C}$).
- Typical values for admissible current at $+25^{\circ}\text{C}$ ambient for a 40°C nominal temperature increase are defined without any heats ink in our literature.
- When using an appropriate cooling device, these values can be slightly increased
- The associated derating curves allow to check maximum current possible in the component versus acceptable temperature increase above ambient temperature of the application.

Example

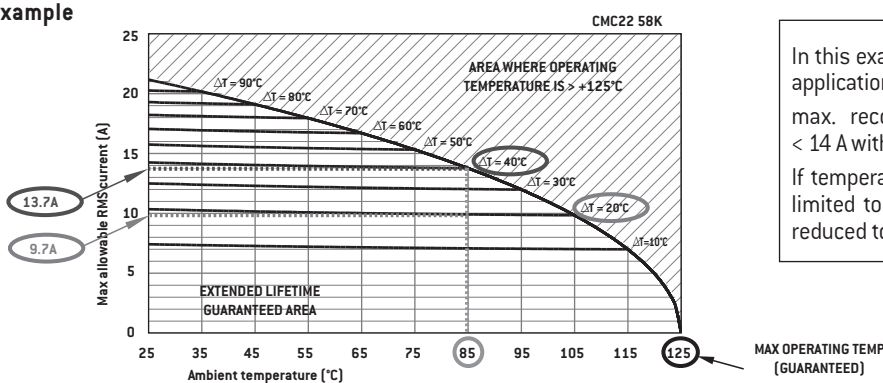

In this example, CMC22 58K is chosen for an application at $T_{\text{amb}} = +85^{\circ}\text{C}$.

max. recommended RMS current is then $< 14\text{ A}$ with $\Delta T < 40^{\circ}\text{C}$.

If temperature increase in the application is limited to $\Delta T < 20^{\circ}\text{C}$, current value must be reduced to $< 10\text{ A}$.

- With the above data, it is clear that the « theoretical » maximum possible current reaches zero for $+125^{\circ}\text{C}$ ambient temperature (because heating above is not recommended) !
- However, it still remains possible to load the component with current leading to operating temperature greater than $+125^{\circ}\text{C}$ but in this case, extended lifetime for the product is not guaranteed any longer.
- Heating values versus current above $+125^{\circ}\text{C}$ operating temperature can still be calculated upon request.