

AS31



Serial assembly of capacitors
Very high voltage
 Polarized

ELECTRICAL AND CLIMATIC CHARACTERISTICS

	AS31
Operating temperature	-55°C +125°C
Capacitance range	18μF ⇨ 733μF
Tolerance	± 10% - ± 20%
Voltage range	150V ⇨ 450V
Max. capacitance change -55°C	see table
Max. capacitance change +85°C	see table
Max. capacitance change +125°C	see table
Max. impedance (100Hz) at -55°C	see table
Max. leakage current at +20°C	see table
Max. leakage current at +85°C	see table
Max. leakage current at +125°C	= lim+85°C
Max. ripple current 40kHz +85°C	see table
Reverse voltage	No
Max. surge voltage at +85°C	1,15 x U _R
Max. surge voltage at +125°C	1,15 x U _C

DIMENSIONS (mm)

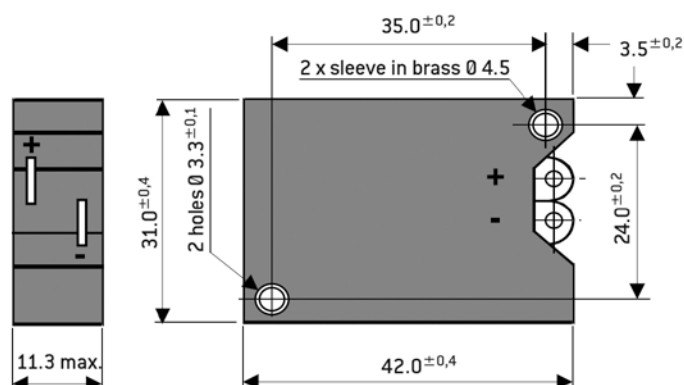

MARKING, PACKAGING, CONSTRUCTION:
 see general characteristics

HOW TO ORDER

Commercial description	Model	Capacitance in μF	Tolerance in %	DC Voltage	Termination	
	AS31N	500μF	20%	150V	H	
EXXELIA PN	Model code	Capacitance code	Tolerance code	DC Voltage code	Termination	
	AS31N	507	M	150	A	
		Expressed in pF with 3 digits: 2 digits for the value and the third for the multiplier	K = 10% M = 20%	Expressed in volt with 3 digits	Commercial description H = SnPb (non RoHS) - = Sn100% (RoHS)	EXXELIA PN A = SnPb (non RoHS) F = Sn100% (RoHS)

STANDARD RATINGS - ELECTRICAL CHARACTERISTICS

Capacitance 100Hz +20°C [μF]	Max. Impedance +20°C [Ω]	Capacitance maximum change			I _{rms} Max.40kHz 100Hz [A]	Max. ESR		Max. I leak	
		-55°C [%]	+85°C [%]	+125°C [%]		100Hz [Ω]	40kHz [Ω]	+20°C [μA]	+85°C [μA]
Rated voltage 150V (+85°C) – 100V (+125°C)									
500	18	-70	+20	+20	3.5	1050	420	15	110
733	13.5	-80	+25	+30	3	1800	720	25	125
Rated voltage 180V (+85°C) – 120V (+125°C)									
186	24	-60	+8	+15	2.75	2400	900	5	40
230	24	-60	+8	+15	2.75	2100	810	7	60
330	16.5	-40	+10	+15	3.5	1500	600	20	120
400	18	-70	+15	+20	3.5	1500	600	20	200
Rated voltage 225V (+85°C) – 150V (+125°C)									
156	30	-60	+6	+10	2.75	2700	900	5	50
250	19.5	-35	+10	+15	3.5	1500	600	20	120
333	24	-65	+12	+20	3.5	1800	720	20	200
Rated voltage 300V (+85°C) – 200V (+125°C)									
73	45	-50	+6	+6	2.75	4800	2100	2	10
133	45	-40	+6	+12	2.5	2400	960	15	150
110	45	-55	+8	+12	2.5	2400	960	25	250
Rated voltage 375V (+85°C) – 250V (+125°C)									
50	54	-35	+6	+12	2.75	4800	1800	5	50
80	60	-35	+6	+12	2.5	2400	960	15	150
110	45	-55	+8	+12	2.5	2400	960	25	250
Rated voltage 450V (+85°C) – 300V (+125°C)									
18.6	141	-24	+15	+15	1.86	2310	920	3	30
273	117	-24	+15	+15	1.86	1650	660	3	30

Electrical characteristics

CAPACITANCE

The capacitance is defined by a rated value (C_R , indicated on the capacitor) and a tolerance (generally $\pm 20\%$).

The capacitance is measured at a 100Hz or at a 120Hz frequency under a 0,1 to 1 V_{AC} voltage and a 2,1 to 2,5 V bias (or 9 to 10 V for $U_R \geq 100$ V).

At room temperature, it must be in the range defined by the rated value and the tolerance.

Capacitance change vs temperature: see typical curves below. Maximum changes are given, for each type, on the data sheets.

CAPACITANCE CHANGE VS TEMPERATURE

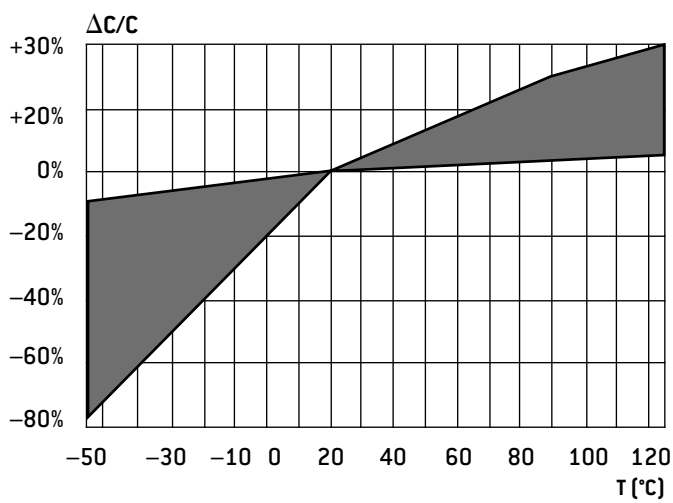

TOLERANCE (ON RATED CAPACITANCE)

It defines, with the rated capacitance, the range in which the capacitance value must be at room temperature.

e.g.: Rated capacitance: $100\mu F$

Tolerance: 20%

The measured capacitance must be between:

$$100 - (20\% \text{ of } 100) = 80\mu F \text{ and } 100 + (20\% \text{ of } 100) = 120\mu F$$

The standard tolerance for tantalum capacitors is 20%.

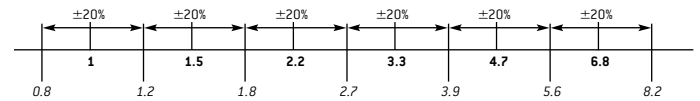

Electrical characteristics

DIRECT DC VOLTAGE

The **rated voltage (U_R)**, indicated on the capacitor, is the maximum DC voltage which can be applied continuously between -55°C and $+85^{\circ}\text{C}$.

For the types which can be used up to 125°C , the voltage must be derated between $+85^{\circ}\text{C}$ and $+125^{\circ}\text{C}$ according to the following curve.

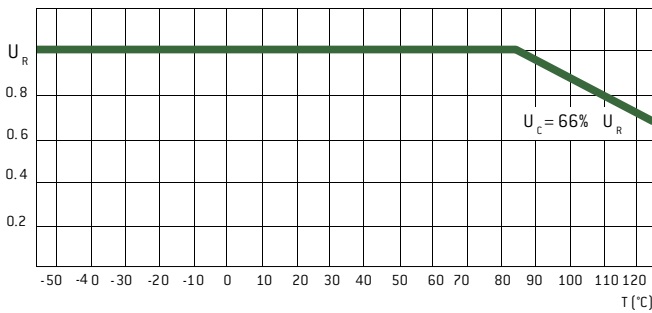

For the types which can be used up to 200°C , the voltage must be derated between $+85^{\circ}\text{C}$ and $+200^{\circ}\text{C}$ according to the following curve.

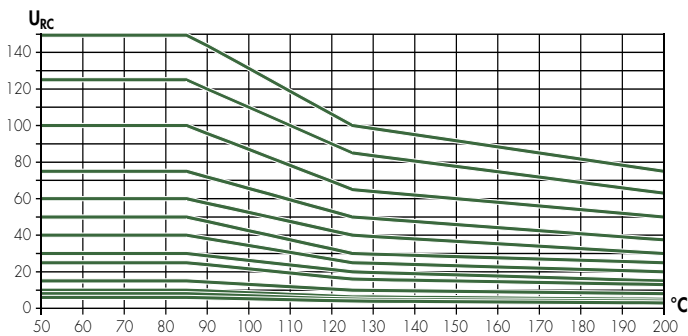

The **category voltage (U_c)** is consequently the maximum DC voltage which can be applied continuously at $+125^{\circ}\text{C}$.

The **surge voltage** is the maximum voltage which can be applied for short periods.

It is given for each type in the data sheet and is generally equal to 1,15 times U_R between -55°C and $+85^{\circ}\text{C}$ and 1,15 times U_c at $+125^{\circ}\text{C}$.

Tests are performed with charging periods of 30 seconds, through a 1000Ω resistor, and discharging periods of 5 min 30s. 1000 cycles are done.

REVERSE VOLTAGE

Capacitors in silver cases (CT4, CT4E, CT9, CT9E) and some in tantalum cases (WT83, WS83) cannot withstand any reverse voltage: it would cause damage, more or less rapidly depending upon the voltage value.

It is therefore necessary to be sure that the bias voltage is high enough to avoid that the AC voltage creates a reverse voltage (negative peak).

Other capacitors in tantalum cases (CT79, CT79E, ST79, DSCC 93026, M39006/22 and M39006/25) can withstand a reverse voltage as specified in the individual datasheet.

LEAKAGE CURRENT

Leakage current is the residual current which flows through the capacitor after the charging time, under rated voltage. It is measured after a time not exceeding 5 minutes and is given in μA .

It is equivalent to the insulation resistance of the capacitor and it must be as low as possible.

Maximum leakage current is a function of capacitance and rated voltage values and is given, for each type, in the data sheets.

LEAKAGE CURRENT CHANGE VS APPLIED VOLTAGE

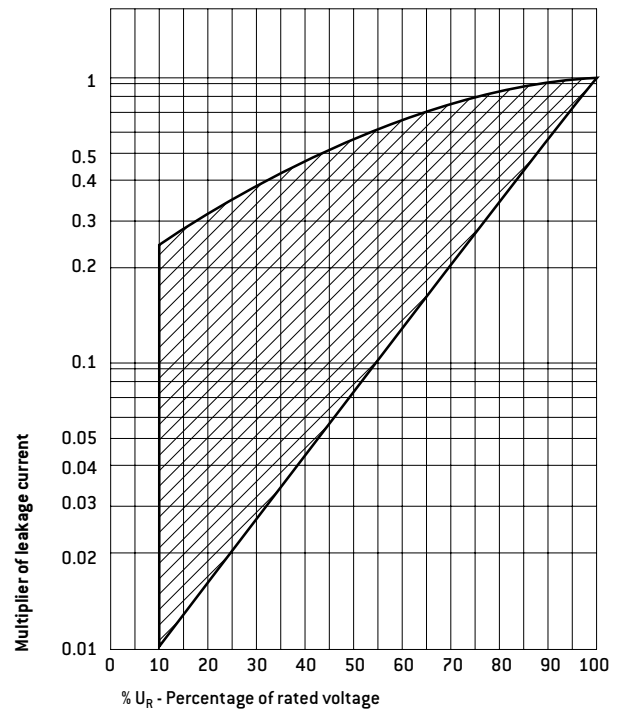

Electrical characteristics

DISSIPATION FACTOR

Dissipation factor is generally measured at the same time as the capacitance, with the same conditions. It is a function of the series resistance of the capacitor and the capacitance at low frequency.

$$DF = ESR \times C \times 2\pi f$$

At low frequency, the series resistance is the sum of an ohmic part (leads, contacts, MnO₂) and the dielectric losses.

Dissipation factor is given in % and maximum limits are given for each type in the data sheets.

EQUIVALENT SERIES RESISTANCE OR IMPEDANCE

Equivalent circuit of a capacitor

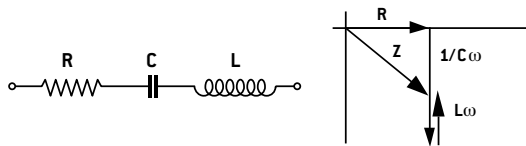

R: equivalent series resistance of the capacitor (leads, contacts, MnO₂, dielectric losses)

L: inductance mainly due to the leads

C: capacitance

Impedance

It is specified at 100Hz and -55°C and the formula for impedance is:

$$Z = \sqrt{R^2 + [L\omega - 1/C\omega]^2}$$

It can be seen that:

- at low frequencies, impedance is a function of capacitance
- at high frequencies, impedance is a function of inductance
- at medium frequencies, it is a function of the ESR

Maximum impedance: see data sheets.

ESR CHANGE VS TEMPERATURE

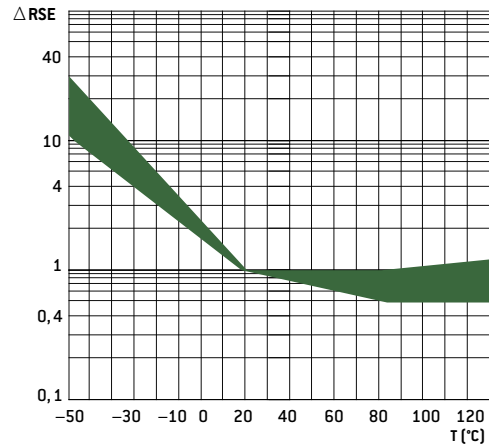

ESR CHANGE VS FREQUENCY

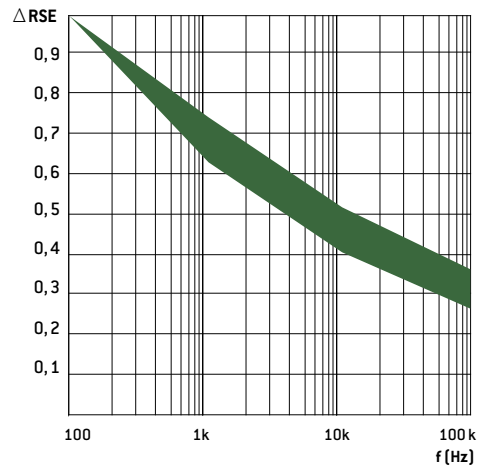

Electrical characteristics

MAXIMUM RIPPLE CURRENT

CT79/79E (SMD) - CT79/79E HT200 - ST79 (SMD) - ST79 HT200 - WT83 - WS83

Maximum ripple currents which are indicated in the data sheets are given for the following conditions:

Temperature: +85°C (+70°C only WT82)

Frequency: 40kHz

Applied voltage: 0,66

If conditions are different, use the multipliers given in the table below to calculate the new maximum current.

Frequency	100Hz				1kHz				10kHz				40kHz				100kHz				
	+55°C	+85°C	+105°C	+125°C	+55°C	+85°C	+105°C	+125°C	+55°C	+85°C	+105°C	+125°C	+55°C	+85°C	+105°C	+125°C	+55°C	+85°C	+105°C	+125°C	
Peak voltage in % of U_R	66%	0,6	0,6	0,46	0,27	0,72	0,72	0,55	0,32	0,88	0,88	0,68	0,4	1	1	0,77	0,45	1,1	1,1	0,85	0,5
	70%	0,6	0,58	0,44	–	0,72	0,7	0,52	–	0,88	0,85	0,64	–	1	0,97	0,73	–	1,1	1,07	0,8	–
	80%	0,6	0,52	0,35	–	0,72	0,62	0,42	–	0,88	0,76	0,52	–	1	0,87	0,59	–	1,1	0,96	0,65	–
	90%	0,6	0,46	–	–	0,72	0,55	–	–	0,88	0,67	–	–	1	0,77	–	–	1,1	0,85	–	–
	100%	0,6	0,39	–	–	0,72	0,45	–	–	0,88	0,55	–	–	1	0,63	–	–	1,1	0,69	–	–

CT4 - CT4E - CT9 - CT9E TYPES

Maximum ripple currents which are indicated in the data sheets are given for the following conditions:

- frequency from 100Hz to 100kHz and more
- temperature from –55°C to +85°C

Correction vs temperature

If the temperature is higher than 85°C, decrease linearly the maximum value from 100% at +85°C to 80% at +125°C.

Correction vs frequency

If frequency is lower than 100Hz, apply the following multipliers to the maximum ripple currents:

75Hz: 0,79 **60Hz:** 0,65 **50Hz:** 0,55 **25Hz:** 0,55

OTHERS RULES (FOR ALL TYPES)

- the sum of the positive peak AC voltage and the DC bias voltage must be lower than the rated voltage.
- the negative peak must not create any Reverse voltage (or maximum 3 volts for CT79 and CT79E types).
- because of the increase of the series resistance at low temperature, it is better to not apply directly the maximum ripple current but to increase this one gradually to raise the capacitor temperature.

CLIMATIC CHARACTERISTICS

1- CLIMATIC CATEGORY

Climatic category defines the temperature range over which the capacitor can be used continuously, and also the number of days for the damp heat test (this test is performed periodically at 40°C with a 93% moisture rate).

Note: it is necessary to derate the voltage for temperatures higher than 85°C (see page 15).

2- THERMAL SHOCKS - RAPID CHANGES OF TEMPERATURE

This test is performed to check that the capacitors can withstand sudden temperature changes. The method which is used is the one with two chambers, one at –55°C, the other one at +125°C. Five cycles are performed, with 30min at low temperature and 30min at high temperature, during the periodical tests (30 cycles for CT79 type). Electrical characteristics are measured after this test.

3 - DAMP HEAT TEST

This test is performed during the periodical test, with the following conditions:

Temperature: 40°C

Humidity: 90 to 95%

DC voltage: without

Time: 21 or 56 days

Electrical characteristics are measured after this test.

MECHANICAL CHARACTERISTICS

1 - VIBRATIONS

This test is performed during the periodical test, with the following conditions:

CT9 - CT9E types

- Frequency: 10 to 2000Hz
- Amplitude: 1,5mm or 196m/s² - 20g
- Time: 6 hours

CT79/79E (SMD) - CT79/79E HT200 - ST79 (SMD) - ST79 HT200 - WT83 - WS83

- Frequency: 10 to 2000Hz
- Amplitude: 3,5mm or 490m/s² - 50g
- Time: 6 hours

2 - SHOCKS

This test is performed just after the vibrations test, with the following conditions for all types:

- Acceleration: 981 m/s² - 100g
- Pulse width: 6 ms
- Shape: 1/2 sinewave
- Number of shocks: 18 (3 in each direction, positive and negative)

Electrical characteristics

RELIABILITY

Reliability of a component can be defined as its probability to work without any failure, in defined conditions and during a fixed time.

Reliability is not therefore only a function of the component quality, but also of the application and environmental conditions.

The parameter which is the most commonly used for the reliability is the failure rate in time, generally expressed in % per 1000 hours.

CALCULATION OF A COMPONENT FAILURE RATE USED IN AN EQUIPMENT

The calculation method on the next page uses parameters which are given by the CNET (Centre National d'Étude des Télécommunications) in its Reliability Data Book (RDF 1993).

The failure rate is calculated with parameters which are function of the capacitor (capacitance, case type, approvals, high surge current test) and others ones which are representative of application conditions (voltage, temperature, resistance in serie, environmental conditions).

Example:

CT79E 2200µF - 6,3 V used under 3 volts, at 40°C, in a satellite in orbit:

$$\pi_t = 1,2 \quad \pi_v = 1,38$$

$$\pi_c = 1,4 \quad \pi_E = 0,5 \quad \pi_q = 1$$

$$\lambda = 3 \times 1,2 \times 1,38 \times 1,4 \times 0,5 \times 1.10^{-9}/h = 3,5.10^{-9}/h = 0,00035\% \text{ defects}/1000 \text{ hours}$$

π_t = TEMPERATURE INFLUENCE

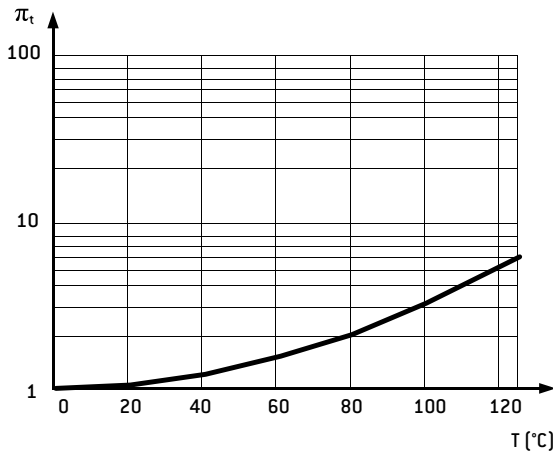

Formula: $\pi_t = \exp [1,8. (t / tm)^2]$

with: t = using temperature
 tm = maximum temperature
 Curve for tm = 125°C

π_v = INFLUENCE OF APPLIED VOLTAGE VS RATED VOLTAGE

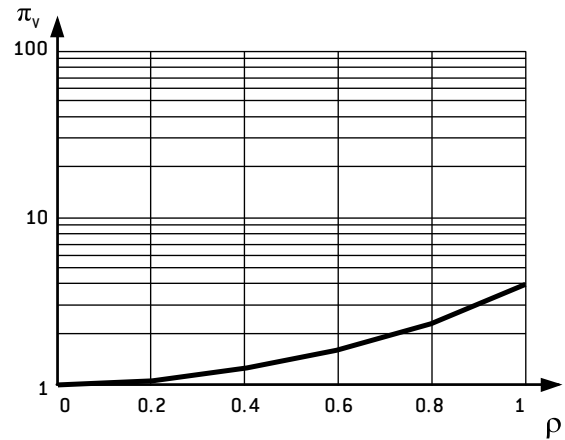

Formula: $\pi_v = \exp [(\rho / 0,85)^2]$

$$\rho = \frac{\text{peak voltage}}{\text{rated voltage}}$$

Curve $\pi_v = f(\rho)$

π_c = INFLUENCE OF CAPACITANCE

3,3µF	$\pi_c = 0,9$
20µF	$\pi_c = 1,0$
1000µF	$\pi_c = 1,3$
2200µF	$\pi_c = 1,4$

π_E = INFLUENCE OF APPLICATION

Satellite in orbit	$\pi_E = 0,5$
Ground; stationary; protected	$\pi_E = 1$
Ground; stationary; non protected	$\pi_E = 2,5$
Ground; mobile; soft conditions	$\pi_E = 6$
Aircraft; soft conditions	$\pi_E = 6$
Ship; soft conditions	$\pi_E = 6$
Ground; mobile; hard conditions	$\pi_E = 8$
Ship; hard conditions	$\pi_E = 10$
Aircraft; hard conditions	$\pi_E = 15$
Satellite; launching	$\pi_E = 20$

π_q = INFLUENCE OF QUALIFICATION

Products approved to CECC	$\pi_q = 1,0$
Others products	$\pi_q = 2,0$

Electrical characteristics

PRODUCT SAFETY INFORMATION SHEET

This should read in conjunction with the Product Data Sheet/Specification.

Failure to observe the ratings, and the information on this sheet may result in a safety hazard.

1. MATERIAL CONTENT

Wet tantalum capacitors contain hazardous materials:

- Liquid electrolyte - gelled diluted sulphuric acid
- Solid tantalum anode

The device consists of solder coated terminal wires and the materials listed below:

- Silver case or tantalum case
- Rubber "o" rings
- PTFE spacers
- Filled epoxy resin end cap on silver case products

2. PHYSICAL FORM

These Capacitors are physically small and are cylindrical with axial leads.

3. INTRINSIC PROPERTIES

3.1 Operating

Wet tantalum capacitors will operate satisfactorily providing that the sum of the applied d.c. and the peak a.c. ripple voltage does not exceed the rated d.c. voltage.

There must be no reversal of polarity.

The maximum ripple currents and voltages and d.c. polarising voltages are specified in the data sheets.

Some tantalum cased devices will stand up to 3 V_{DC} Reverse for short periods of time.

A Reverse application of the rated voltage will result in loss of capacitance, early short circuit failure and may result in fire or explosion.

It may also cause consequential failure of other associated components in circuit, e.g. diodes, transformers, etc.

3.2 Non-Operating

Wet Tantalum capacitors contain electrolyte which is a conducting material.

If electrolyte leaks onto a printed circuit board or similar insulated support, short circuits can be caused.

All electrolytes are corrosive to some extent.

No electrolyte should be allowed to come in contact with the skin, eyes, etc., and if they do appropriate medical treatment should be applied.

CONSTRUCTION

CT79/79E (SMD) - CT79/79E HT200 - ST79 (SMD) - ST79 HT200 - WT83 - WS83

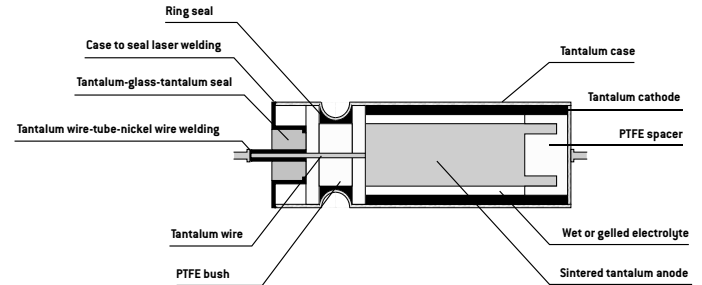

Glass metal seal: CT9 - CT9E

Epoxy sealing: CT4 - CT4E

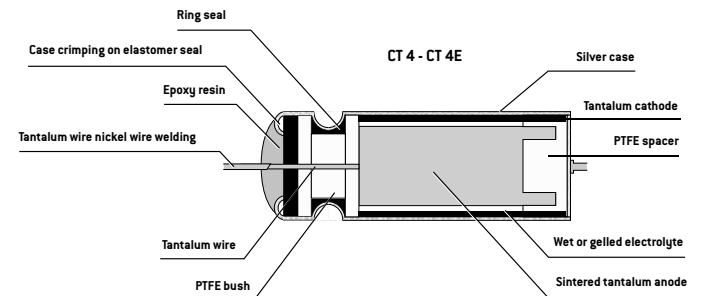
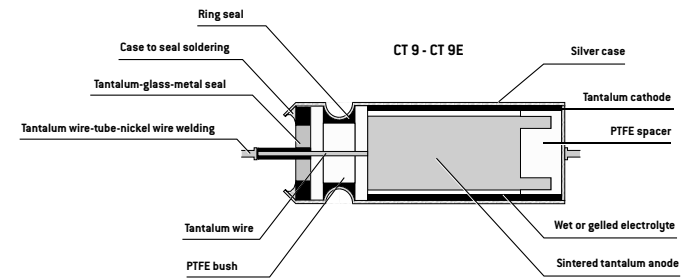

MARKING (except DSCC 93026, M39006/22, M39006/25)

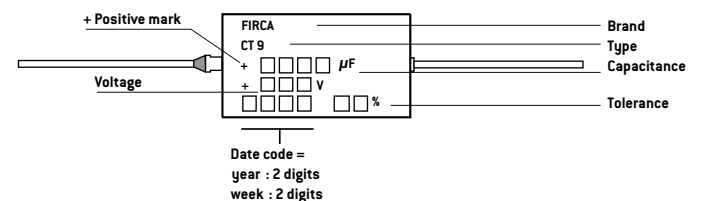

PACKAGING

In cardboard boxes

General information

Tantalum capacitors are, with ceramic, aluminum and film capacitors, one of the most used family.

The manufacturing technology and the constant improvements in tantalum powders allow it to be the capacitor with the highest CV (product capacitance x voltage) per volume, very long life and high reliability.

It has also the following advantages:

- Wide range of capacitance (less than 1 μ F to more than 10 000 μ F)
- Wide operating temperature range (-55°C to +200°C)
- Electrical characteristics stable with temperature
- Low leakage current
- Very low ESR for some types
- Stability after long periods of storage, without any reforming

All these characteristics allow tantalum capacitors to be commonly used either in large volume markets like mobile phones or computers, or in specific High-Rel applications such as space, aerospace and military.

Its main uses are found in the following functions:

- Filtering
- Bypass
- Coupling
- RC time constant
- Energy storage

Tantalum capacitors can be divided into two main families and several sub-families:

Solid tantalum capacitors:

- Solid MnO₂
 - Metal cases
 - Molded cases
 - SMD
- Solid Polymer
 - SMD

Wet tantalum capacitors:

- Silver cases
- Tantalum cases

HOW TO USE THE SELECTION GUIDE

- 1 - The **Technical Selection Guide** can be used to select a product according to the main technical requirements.
- 2 - The **Classification according to specification** makes the link between all major standard specifications and the products.
- 3 - The **Selection Guide** by family has the same classification as in the catalogue. You will find for each type the main features, the approvals and the page number of the technical data sheet.

MANUFACTURING

ANODE AND INSULATOR

Tantalum capacitors are the capacitors which have the highest ratio of capacitance per volume. This is mainly due to the high dielectric coefficient of its insulator and to its large cross-section.

The basic raw material is a high purity (greater than 99,99%) tantalum powder with a very fine granulation, compressed to form a cylinder or a parallelepiped constituting the anode of the capacitor (positive plate).

The pellet is then sintered at high temperature (1200°C to 2200°C), under high vacuum (10⁻⁶ Torr), firstly to purify the powder and secondly to obtain a strong mechanical structure by a welding of the particles.

The insulating part is obtained by anodization to a depth of the tantalum surface which forms a tantalum pentoxide film (Ta₂O₅) with a thickness of about 16 angstroms per anodization volt. The dielectric coefficient is between 21 and 27 depending upon the anodization conditions.

WET ELECTROLYTE: CATHODE AND ENCAPSULATION

In this case, the cathode is formed by a sulphuric acid solution. The anodized tantalum pellet is impregnated with this solution and then placed in a silver or tantalum case, into which some equivalent gelled solution have been previously deposited.

The case is then crimped on the internal PTFE gasket to make the sealing. The final steps are welding (CT79), soldering (CT9) or elastomer seal (CT4) depending on the capacitors.

SOLID ELECTROLYTE: CATHODE AND ENCAPSULATION

In this case, the cathode is formed either by manganous dioxide which is a grey semi conductor or by polymer solution.

Solid MnO₂ cathode is obtained by dipping the pellets into a manganous nitrate water solution which impregnates the internal structure; this solution is then decomposed in a high temperature oven to obtain manganous dioxide. This operation is repeated several times. The nature and quality of this semiconductor are important to some of the electrical parameters (especially the serial resistance).

To finish the negative plate, a graphite coating and then a silver coating are deposited on the outside surface of the manganous dioxide or conducting polymer.

The positive nickel lead is welded on the tantalum wire and the negative lead is either soldered for the products with axial leads or glued with a silver epoxy for the SMD range.

BURN-IN - SORTING - INSPECTION

All the products are submitted to a final burn-in, with differing severities depending upon the characteristics of each type (temperature, voltage, duration).

Then follows the sorting, marking and inspection operations. It can be noted that the procedures for these operations are the same for approved and non approved parts (except the periodical tests).

General information

TYPE IDENTIFICATION - ORDERING INFORMATION

THE COMPLETE IDENTIFICATION OF A PRODUCT IS MADE OF

- The type (or model)
- The tolerance
- The case size
- The rated voltage
- The rated capacitance
- If applicable the CECC specification number

THE TYPE

It can be expressed with the commercial description (CTC21E C 33 μ F 10% 40V) or the **EXXELIA** part number (TS22EC336K040F).

When applicable the CECC specification number should be indicated.

THE CASE SIZE

It is indicated on the technical data sheets in front of each capacitance-voltage value and is generally identified by a letter code. It is important to give this information because there can be, for the same type, a standard range and an extended range in which the same value will be available in two different sizes.

THE RATED CAPACITANCE

It can be expressed:

- Directly in μ F (eg: 47 μ F)
- Coded according to MIL specification, with:
 - 2 digits number for the value
 - A multiplying factor to obtain the capacitance in pF (power of 10)

Eg: 567 = 56.10⁷ pF = 560 μ F

THE TOLERANCE

It can be expressed directly in % or identified by a code letter:

M = \pm 20%

K = \pm 10%

J = \pm 5%

N.B.: the standard tolerance for tantalum capacitors is 20%; if no tolerance is specified, it would be considered as 20%.

A 20% tolerance means in fact -20% to +20%.

THE RATED VOLTAGE

It is expressed directly in volts (V)

N.B.: 6,3V rated voltage can be coded as 6V.

CECC SPECIFICATIONS

Some of the products which are described in this catalogue are made to a CECC specification; these documents give in detail the following information for each type:

- The climatic, electrical and mechanical characteristics
- The test and inspection procedures
- The sampling methods and levels
- The tests periods

The reference specifications concerning the tantalum capacitors are the following:

CECC 30 000 (NFC 83-100)

Generic specification: fixed capacitors

- Terminology
- Quality Assessment Procedures
- Test and inspection methods

CECC 30 200 (NFC 83-112)

Sectional specification: tantalum capacitors

- Preferred characteristics
- Quality Assessment Procedures
- Test and inspection methods

CECC 30 201 XXX

Detail specifications solid tantalum capacitors

- Detailed characteristics for each type

CECC 30 202 XXX

Detail specifications wet tantalum capacitors

- Detailed characteristics for each type

CECC 30 800 (NFC 83-113)

Sectional specification: tantalum chip capacitors

- Preferred characteristics
- Quality Assessment Procedures
- Test and inspection methods

CECC 30 801 XXX

Detail specifications tantalum chip capacitors

- Detailed characteristics for each type
- The list of all the detail specifications is given in the selection guide, with the corresponding type.

NB: Some of the products refer to specifications which are no longer published.

OTHER SPECIFICATIONS

In addition to CECC approvals, some of the products are qualified to MIL standard M39006/22, M39006/25, DSCC DWG No. 93026 and some others are listed in ESA (European Space Agency) Preferred Parts Lists ESCC EPPL I or II.