

# ALSIC 20G

8 000 h / 105°C

10 V ... 500 V	33 µF ... 80 000 µF	Ø 18 [0,709] ... Ø 35,5 [1,398]	- 55°C + 105°C	Long life time
----------------	---------------------	---------------------------------	----------------	----------------



## APPLICATIONS

- Automotive
- High frequency switched mode power supplies
- High ripple current
- Low inductance
- Low impedance

Insulating aluminum case  
Tin coated leads  
Negative pole marked

Tolerance on capacitance at 20°C : ± 20 %  
Operating temperature : - 55°C + 105°C

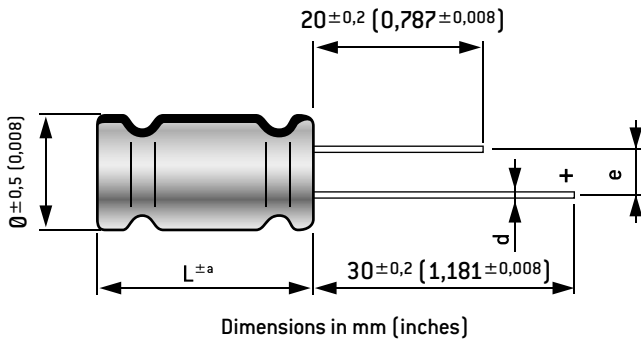

## DIMENSIONS in mm (inches)

Ø	e±0,5 [0,020]	d	b±2 [0,079]	±a	c±2 [0,079]
18 [0,709]	7,5 [0,295]	0,8 [0,031]	15 [0,591]	1 [0,039]	20 [0,787]
22,5 [0,886]	8,3 [0,327]	1,2 [0,047]	25 [0,984]	2 [0,079]	30 [1,181]
35,5 [1,398]					

## RESISTANCE TO VIBRATIONS

	Standard
f [Hz]	10 - 2000 Hz
Amplitude	1,5 [0,059]
Acceleration	20 g - 196 m/s <sup>2</sup>
t [h]	3 x 2 h

## SPECIFICATIONS

NFC 83 110 - Long life  
CECC 30 300  
IEC 60 384-4 Long life  
Standard endurance test at U<sub>R</sub>: 5000h / 105°C  
Climatic category GPF: - 55°C + 105°C / 56 days

## WITHSTAND STRENGTH OF INSULATING SLEEVE

Insulation resistance at 20°C between leads and mounting hardware : 100 MΩ  
Test voltage at 50 Hz 1 min. between terminals and mounting hardware : 1 000 V  
Fire resistance : self extinguish 30 s (IEC 60 695-2-2)

8 000 h / 105°C

Capacitance ( $\mu$ F)	Case		ESR 100 Hz +20°C max. (m $\Omega$ )	Tan $\delta$ 100 Hz +20°C Typic (%)	Z 100 Hz+20° C Typic (m $\Omega$ )	I. leak +20°C 5 min. max. (mA)	I <sub>~</sub> +105°C 100 Hz (A)	Code		
	$\emptyset$ mm (inches)	L mm (inches)								
<b>Rated voltage/Peak voltage: 10 / 12 V</b>										
15000	18	[0,709]	40	[1,575]	53	21	26	0,9	3,9	A776100
<b>Rated voltage/Peak voltage: 16 / 18 V</b>										
8200	18	[0,709]	35	[1,378]	72	17	33	0,79	2,9	A776101
14000	22,5	[0,886]	40	[1,575]	48	19	23	1,35	3,9	A776102
66000	35,5	[1,398]	45	[1,772]	45	83	24	6,34	11,7	A776103
80000	35,5	[1,398]	50	[1,969]	44	97	24	8,10	12,4	A776104
<b>Rated voltage/Peak voltage: 25 / 29 V</b>										
3700	22,5	[0,886]	40	[1,575]	57	6	24	0,56	3,7	A776105
<b>Rated voltage/Peak voltage: 35 / 40 V</b>										
2200	18	[0,709]	35	[1,378]	129	8	58	0,47	2,9	A776106
2700	18	[0,709]	35	[1,378]	107	8	48	0,57	3,3	A776107
3300	18	[0,709]	30	[1,181]	91	8	40	0,70	2,9	A776108
4700	18	[0,709]	35	[1,378]	72	9	32	0,99	3,3	A776109
5800	18	[0,709]	40	[1,575]	59	9	25	1,22	3,5	A776110
<b>Rated voltage/Peak voltage: 50 / 58 V</b>										
2200	18	[0,709]	35	[1,378]	86	5	37	0,66	2,9	A776111
2700	18	[0,709]	40	[1,575]	73	6	31	0,81	3,3	A776112
3000	18	[0,709]	40	[1,575]	67	6	28	0,90	2,9	A776113
3300	18	[0,709]	40	[1,575]	66	6	28	0,99	3,9	A776114
<b>Rated voltage/Peak voltage: 63 / 72 V</b>										
600	22,5	[0,886]	25	[0,984]	224	4	97	0,23	2,1	A776115
2700	25,5	[1,004]	40	[1,575]	66	5	28	1,02	4,3	A776116
3000	25,5	[1,004]	40	[1,575]	64	5	27	1,14	3,5	A776117
4700	25,5	[1,004]	40	[1,575]	61	8	26	1,78	3,2	A776118
<b>Rated voltage/Peak voltage: 100 / 115 V</b>										
2200	30,5	[1,201]	40	[1,575]	79	5	33	1,32	5,1	A776119
<b>Rated voltage: 160 V</b>										
220	22,5	[0,886]	25	[0,984]	615	4	270	0,22	0,8	A776120
330	22,5	[0,886]	30	[1,181]	371	3	160	0,32	1,1	A776121
470	25,5	[1,004]	30	[1,181]	275	4	118	0,46	1,5	A776122
1000	30,5	[1,201]	40	[1,575]	156	4	68	0,96	2,3	A776123
2200	35,5	[1,398]	50	[1,969]	120	7	54	2,12	3,4	A776124
<b>Rated voltage: 200 V</b>										
220	22,5	[0,886]	25	[0,984]	524	3	223	0,27	0,8	A776125
330	22,5	[0,886]	30	[1,181]	342	3	144	0,40	1,1	A776126
470	25,5	[1,004]	30	[1,181]	270	3	115	0,57	1,5	A776127
680	30,5	[1,201]	40	[1,575]	196	4	84	0,82	1,9	A776128
1000	30,5	[1,201]	50	[1,969]	141	4	60	1,20	2,6	A776129
1500	35,5	[1,398]	50	[1,969]	128	5	56	1,80	3,0	A776130
1700	35,5	[1,398]	50	[1,969]	128	6	56	2,04	4,2	A776131
<b>Rated voltage: 250 V</b>										
100	22,5	[0,886]	25	[0,984]	961	3	400	0,15	0,6	A776132
150	22,5	[0,886]	25	[0,984]	665	3	278	0,23	0,7	A776133
220	22,5	[0,886]	30	[1,181]	451	3	188	0,33	1,0	A776134
330	25,5	[1,004]	30	[1,181]	323	3	135	0,50	1,3	A776135
390	25,5	[1,004]	40	[1,575]	271	3	113	0,59	1,4	A776136
470	25,5	[1,004]	40	[1,575]	240	3	101	0,71	1,8	A776137
680	25,5	[1,004]	50	[1,969]	182	3	76	1,02	2,3	A776138
1000	30,5	[1,201]	50	[1,969]	144	4	61	1,50	2,9	A776139
1300	35,5	[1,398]	50	[1,969]	133	5	58	1,95	3,7	A776140

# ALSIC 20G

8 000 h / 105°C

Capacitance (µF)	Case		ESR 100 Hz +20°C max. (mΩ)	Tanδ 100 Hz +20°C Typic (%)	Z F(1) 100 Hz+20° C Typic (Ω)	I. leak +20°C 5 min. max. (mA)	I~ +105°C 100 Hz (A)	Code
	Ø mm (inches)	L mm (inches)						
<b>Rated voltage: 350 V</b>								
100	22,5 (0,886)	25 (0,984)	1045	3	442	0,21	0,7	A776141
220	30,5 (1,201)	40 (1,575)	484	3	204	0,47	1,2	A776142
470	35,5 (1,398)	40 (1,575)	279	4	121	0,99	2,1	A776143
680	35,5 (1,398)	50 (1,969)	202	4	87	1,43	2,7	A776144
<b>Rated voltage: 400 V</b>								
68	22,5 (0,886)	25 (0,984)	2096	4	931	0,17	0,5	A776145
100	22,5 (0,886)	30 (1,181)	1423	4	631	0,24	0,6	A776146
150	22,5 (0,886)	40 (1,575)	956	4	424	0,36	0,9	A776147
220	25,5 (1,004)	40 (1,575)	670	4	297	0,53	1,3	A776148
330	30,5 (1,201)	40 (1,575)	474	4	211	0,80	1,5	A776149
470	30,5 (1,201)	50 (1,969)	338	4	150	1,13	2,0	A776150
680	35,5 (1,398)	50 (1,969)	264	5	118	1,64	2,5	A776151
<b>Rated voltage: 450 V</b>								
33	18 (0,709)	35 (1,378)	3842	4	1683	0,09	0,4	A776152
47	18 (0,709)	25 (0,984)	2720	4	1192	0,13	0,3	A776153
47	18 (0,709)	35 (1,378)	2704	4	1184	0,13	0,4	A776154
47	22,5 (0,886)	25 (0,984)	2720	4	1192	0,13	0,4	A776155
68	22,5 (0,886)	25 (0,984)	1902	4	834	0,19	0,5	A776156
100	22,5 (0,886)	40 (1,575)	1283	4	561	0,27	0,7	A776157
150	22,5 (0,886)	40 (1,575)	870	4	380	0,41	0,8	A776158
220	25,5 (1,004)	50 (1,969)	597	4	261	0,60	1,3	A776159
330	30,5 (1,201)	40 (1,575)	444	4	196	0,90	1,5	A776160
470	35,5 (1,398)	40 (1,575)	354	5	158	1,27	2,0	A776161
<b>Rated voltage: 500 V</b>								
47	22,5 (0,886)	30 (1,181)	2416	3	1040	0,15	0,4	A776162
100	25,5 (1,004)	40 (1,575)	1150	3	495	0,30	0,6	A776163
150	30,5 (1,201)	40 (1,575)	784	3	338	0,45	0,8	A776164
220	30,5 (1,201)	50 (1,969)	540	3	232	0,66	1,4	A776165
330	35,5 (1,398)	50 (1,969)	382	4	165	0,99	1,8	A776166

F(1): Ø ≤ 18 mm = 100 kHz  
Ø > 18 mm = 10 kHz

### MAX IMPEDANCE 100 kHz, 20°C

Z max ≅ Z typ. x 1.3

### EXPECTED LIFE

As a function of temperature and ripple current.

### PERMISSIBLE RIPPLE CURRENT I (R.M.S. VALUE)

versus frequency f:

I~: permissible r.m.s. current at 100 Hz

f (Hz)	50	100	300	600	1 000	10 000	≥ 50 000
I	0,8 x I~	I~	1,2 x I~	1,3 x I~	1,35 x I~	1,5 x I~	1,6 x I~

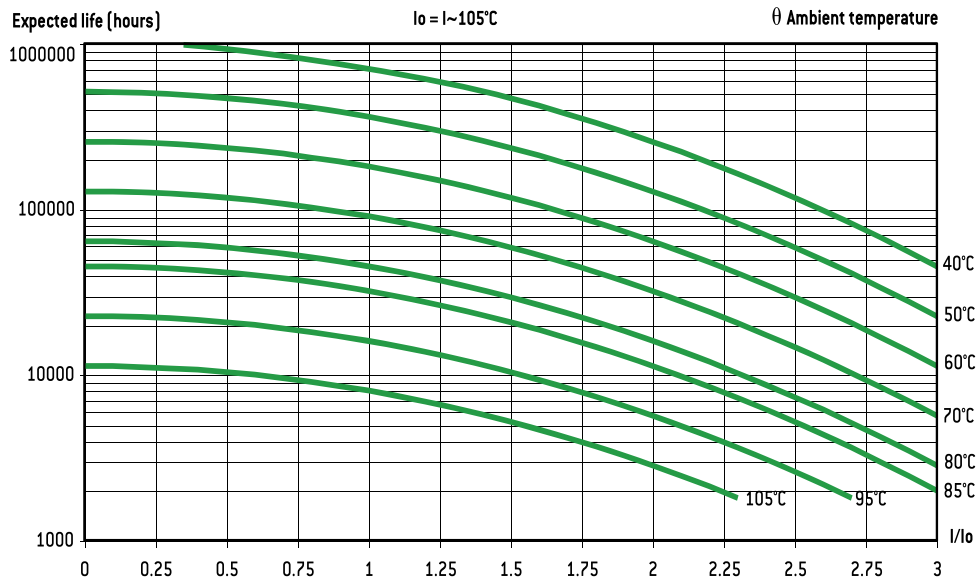

# General technical data

## 1. BASIC CONSTRUCTION

Structure of an electrolytic aluminum capacitor is shown hereunder:

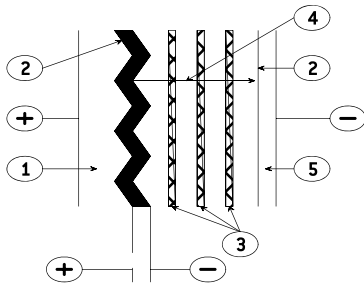

1. Anode: aluminum foil
2. Dielectric: aluminum oxide
3. Papers spacers impregnated with electrolyte
4. Ionic conduction assumed by electrolyte
5. Cathode: aluminum foil

The positive plate is an etched aluminum foil covered with alumina which is the dielectric of the capacitor.

The negative plate is constituted by a second aluminum foil which serves as a current supply, and by electrolyte-impregnated papers layers.

The metal used for anode is a  $\geq 99,98$  % grade aluminum.

The dielectric has a thickness of  $13 \text{ \AA} / \text{V}$ .

The aluminum used for the cathode is a  $\geq 98$  % grade aluminum covered with a dielectric layer with a thickness of about  $40 \text{ \AA}$ .

## 2. DIAGRAM OF THE EQUIVALENT CIRCUIT

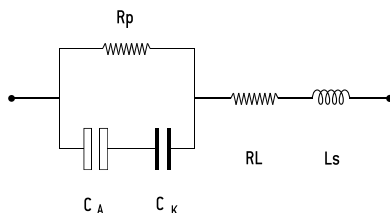

- $C_A$  = Capacitance of the anode  
 $C_K$  = Capacitance of the cathode  
 $R_p$  = Parallel resistance due to the aluminum oxide film.  
 $R_L$  = Series resistance of connections, plates and impregnated spacer.  
 $L_s$  = Inductance of winding and connections.

A standard simplified diagram is.

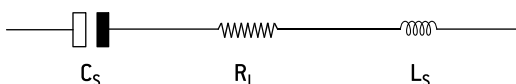

$C_s$  is the series capacitance of both anode and cathode capacitances. Electrolytic aluminum capacitors are naturally polarized because of the insulating film on the anode. Given the very thin aluminum oxide layer, a reversed voltage should not exceed 1.5 V when there is energy supply.

Short duration reverse voltages can be absorbed by special construction, second anode replacing the former cathode.

## 3. CAPACITORS MARKING

### 3.1. ARTICLE CODE (ON EACH PACKAGING)

A followed by 6 figures number. First 3 positions are specific of the range. (Ex. A 745xxx for a FELSIC 85 BD)

140 FELSIC in bank	741 FELSIC 125 FRS BD (ex 731)
701 PRORELSIC 125	742 PRORELSIC 105 TFRS
703 PRORELSIC 125	743 PRORELSIC 105 TFRS
704 SNAPSIC	744 FELSIC 85 BC
705 SNAPSIC 105	FELSIC 85 LP
706 FELSIC HP BC – BD	745 FELSIC 85 BD
708 PRORELSIC 145	746 FELSIC 85 M BC
710 CUBISIC	747 FELSIC 85 M BD
711 PROMISIC 031	748 SICAL CO 42 - SICAL
712 CUBISIC LP	749 SICAL CO 42 - SICAL
713 SNAPSIC 105 LP	750 CUBISIC 125
714 SNAPSIC 4P	756 FELSIC 105 BC
715 SNAPSIC 105 4P	FELSIC 105 LP
716 SNAPSIC HV	757 FELSIC 105 BD
717 SNAPSIC HC	760 FELSIC HC BC
718 SNAPSIC 125	761 FELSIC HC BD
721 RELSIC 033	762 FELSIC 105 TFRS BC
722 CI FRS	763 FELSIC 105 TFRS BD
723 CI FRS	764 FELSIC HV BC
728 FELSIC 039 (ex 727)	765 FELSIC HV BD
FELSIC DI	775 VACSIC
738 FELSIC 037 (ex 737)	774 VACSIC 150
740 FELSIC 125 FRS BC (ex 731)	776 ALSIC 20G
	ALSIC 145 20G

In FELSIC ranges, article code without first letter A, is printed on each capacitor.

a Figure 9 in fourth position shows a special product.

### 3.2. BATCH (ON EACH CAPACITOR).

3 figures or 6 figures

### 3.3. DATE (ON EACH CAPACITOR IF APPLICABLE)

4 figures (year-week)

## 4. ELECTRICAL CHARACTERISTICS

### 4.1. RATED CAPACITANCE $C_R$

The rated capacitance is defined at 100 Hz and at ambient temperature.

### 4.2. RATED VOLTAGE $U_R$

$U_R$  is the maximum DC voltage which may be applied in continuous operation.

When applying a superimposed alternating voltage, the peak value of the resulting waveform should not exceed the rated voltage.

### 4.3. PEAK VOLTAGE $U_p$

$U_p$  is the maximum repetitive voltage which can be applied within short periods.

Defined in CECC 30 300 and IEC 60 384-4:

1000 cycles of 30 s charge followed by a no load period of 5 min. 30 s with upper category temperature.

$$U_p \leq 1,15 U_R (U_R \leq 315 \text{ V})$$

$$U_p \leq 1,10 U_R (U_R > 315 \text{ V})$$

# General technical data

## 4.4. DISSIPATION FACTOR $\tan\delta$

The dissipation or loss factor is defined by its tangent  $\tan\delta$

$$\tan\delta = R_s C_s \omega$$

$$(\omega = 2\pi F)$$

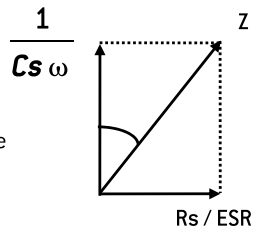

- ESR** Capacitor Equivalent Series Resistance  
**Cs** Capacitor capacitance  
**F** Frequency (100 Hz)  
**Z** Capacitor impedance

## 4.5. EQUIVALENT SERIES RESISTANCE ESR

The relation between ESR and dissipation factor  $\tan\delta$  is given in § 4.4.

## 4.6. IMPEDANCE Z - INDUCTANCE L

The impedance is given by:

$$Z = \sqrt{R^2 + \left[L\omega - \frac{1}{C\omega}\right]^2}$$

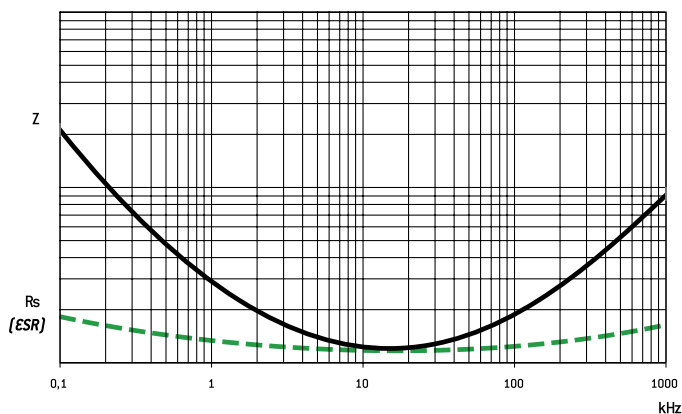

L inductance. Generally L = 5 to 20 nH  
 Z and ESR as function of frequency typically follows the chart:

## 4.7. PERMISSIBLE RIPPLE CURRENT (I r.m.s.) I<sub>r</sub>

The current is defined at the maximum climatic category and at 100 Hz. It is the root mean square value r.m.s. The value I<sub>0</sub> is the rated value for calculations of expected life up to 3 I<sub>0</sub>.

## 4.8. LEAKAGE CURRENT II

II is measured at 20°C after a 5 min. polarization under rated voltage.

For C<sub>R</sub> in μF and U<sub>R</sub> in V:

$$II \leq 0,01 C_R U_R \text{ or } 1 \mu\text{A}^*$$

when C<sub>R</sub> U<sub>R</sub> ≤ 1000 μC

$$II \leq 0,006 C_R U_R + 4 \mu\text{A}$$

when C<sub>R</sub> U<sub>R</sub> > 1000 μC

For U<sub>R</sub> > 350 V<sub>DC</sub> it can be specified:

with K = 4, 6 or 8

or

$$II \leq 0,3 [C_R U_R]^{0,7} + 4 \mu\text{A} \text{ (CECC 30 300)}$$

\* Whichever is the greater

## 4.9. CHARACTERISTICS

Versus temperature (typical values).

### 4.9.1. Capacitance drift

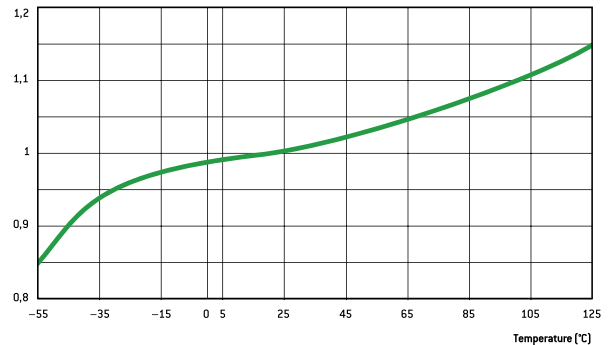

Versus temperature

### 4.9.2. ESR and Z drifts at 100 Hz

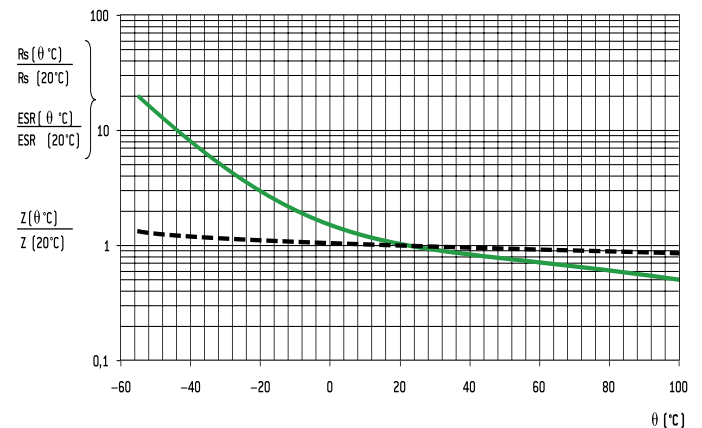

Versus temperature

### 4.9.3 Leakage current drift

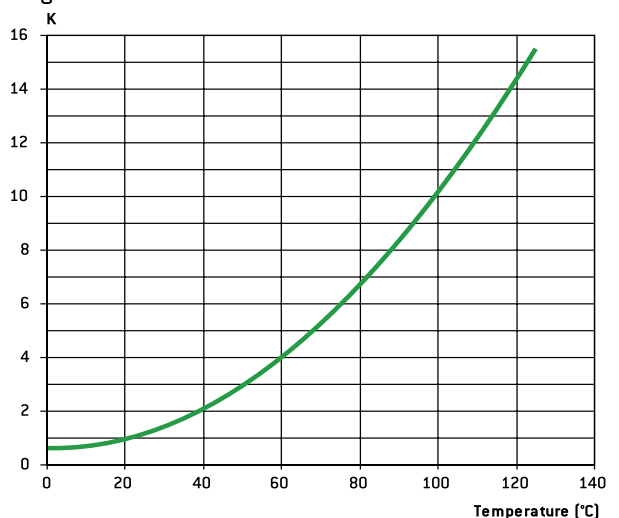

Versus temperature

# General technical data

## 5. SPECIFICATION TO APPLY

Electrolytic aluminum capacitors are defined in:

- NF and UTE French national standard
- CECC European specifications
- IEC international specifications

Quality insurance procedures are described in these specifications.

	French	European	International
Generic specification Fixed capacitors	NF C 83 100	CECC 30 000 EN 130 000	IEC 60 384 -1 QC 300 000
Sectional specification Electrolytic aluminum capacitors	NF C 83 110	CECC 30 300	IEC 60 384 - 4 C 300 300
Blank deta II specification - Electrolytic aluminum capacitors with non solid electrolyte.	UTE 83 110	CECC 30 301	IEC 60 384 - 4 -1 QC 300 301
Blank deta II specifications	CECC 30 301-017 to CECC 30 301-062 C0 31 to C0 55	CECC 30 301-017 to CECC 30 301-062 CECC 30 301-802 to CECC 30 301-811	

## 6. ENDURANCE TESTS / LIFE TIME

### 6.1. STANDARD ENDURANCE TEST

at max category temperature:

Standard endurance tests do not exceed 2000 hours at 125°C. However,

Temperature	Endurance test			
	Grade I - Long life			Grade II - General purpose
	10 000 h	5 000 h	2 000 h	1 000 h
125°C			•	
105°C		•	•	•
85°C	•	•	•	•

present EXXELIA technologies concerning liquid electrolytes have led to endurance tests up to 5000 hours at 125°C (PRORELSIC 125 - FELSIC 125 RS) and even 20000 hours at 125°C (PRORELSIC 145 - ALSIC 145)

### 6.2. PERFORMANCE REQUIREMENTS ON STANDARD ENDURANCE TESTS.

Permissible capacitance drift  $\Delta C/C$  (%)

Permissible increase factors on  $\tan\delta$ , ESR, Z and II initial values

(1)  $\tan\delta$  or ESR: for initial value, take standard value.

$U_R$	Endurance test			
	Grade I			Grade II
	10 000 h	5 000 h	2 000 h	1 000 h
6,3 V			+15 -30	+25 -40
10 V - 35 V	+15 -20	±15	±15	±30
40 V - 160 V	±15	±15	±15	±30
> 160 V	±15	±10	±10	±15

	Endurance test			
	Grade I			Grade II
	10 000 h	5 000 h	2 000 h	1 000 h
$\tan\delta$ or ESR [1]	1,5	1,3	1,3	1,5
Z [2]	3	2	2	3
II	Standard values			

[2] Z: for initial value, take specified value [see data sheet ].

Specific requirements can be taken into consideration with regards to initial values of dissipation factor or equivalent series resistance and impedance.

## 6.3. FAILURE CRITERIA FOR ELECTROLYTIC CAPACITORS.

Failure criteria are defined in CECC 30 301

- Non measurable defaults leading to complete failure.
- Measurable defaults leading to adjustment losses of the load circuit (failure due to variations).

### 6.3.1. Non measurable defaults.

They might be summed up as:

- Open circuit
- Short circuit
- Operation of pressure relief device
- Severely damaged insulation
- Unusable terminations

### 6.3.2. Measurable defaults.

Variations exceeding the values given below characterize a default.

- Capacitance drift  $\Delta C/C$  (%): 3 times the limit for standard endurance testing or 50 % (whichever is the smallest).
- $\tan\delta$  or ESR: 3 times standard max initial values.
- Z: 3 times standard max initial values.
- II: initial limit (under load conditions).

Specific requirements can be taken into consideration with regards to lower drifts.

## 6.4. INFLUENCE OF MAIN PARAMETER ON OPERATIONAL LIFE.

### 6.4.1. Temperature.

The capacitors operational life is highly dependent upon its internal temperature  $\Theta_i$  and therefore upon the ambient temperature and the ripple current.

Knowing ESR and dissipated power values (§ 6.4.3.) one can figure out, the internal temperature rise and then determine the capacitors expected life.

With present high boiling point electrolytes (§ 8.6)

$\Theta_i \text{ max} = 125 \text{ to } 185^\circ\text{C}$  depending on styles.

### 6.4.2. Ripple current.

The ripple current flowing through the capacitor increase the internal temperature through power dissipation.

Standards define the permissible current at 100 Hz and generally consider a temperature rise of 5 to 10°C of max category temperature.

Current waveforms and frequencies make it difficult to clearly determine the capacitors internal temperature rise, which defines the operationally life.

Experiments confirm following relationship:

$$\Theta_i = \Theta_a + (\Theta_c - \Theta_a) K$$

Where:

- $\Theta_i$  = Internal hot spot temperature
- $\Theta_a$  = Ambient temperature
- $\Theta_c$  = Case temperature
- K = Parameter depending upon case diameter and cooling
  - $\emptyset \geq 51 \text{ k} = 2 \pm 0,5$
  - $\emptyset < 51 \text{ k} = 1,5 \pm 0,5$  [air cooling - 0,2 m/s]

# General technical data

r.m.s. value according to current waveform.

one capacitor diameter

Function	Mean value	R.m.s. value	Function	Mean value	R.m.s. value	Function	Mean value	R.m.s. value
	$A (t_0/T)$	$A \sqrt{t_0/T}$		$A/2$	$A \sqrt{3}$		$2A/\pi$	$A/\sqrt{2}$
	$A (t_1/T)$	$A \sqrt{2t_1/3T}$		$2A/\pi (t_0/T)$	$A \sqrt{t_0/2T}$		$A/2$	$A/\sqrt{3}$
	$A/2 (t_0/T)$	$A \sqrt{t_0/3T}$		$A/2 (t_0/T)$	$A \sqrt{t_0/3T}$		0	A

### 6.4.3. Dissipated power versus case dimension

For calculations of ripple currents, considering an internal

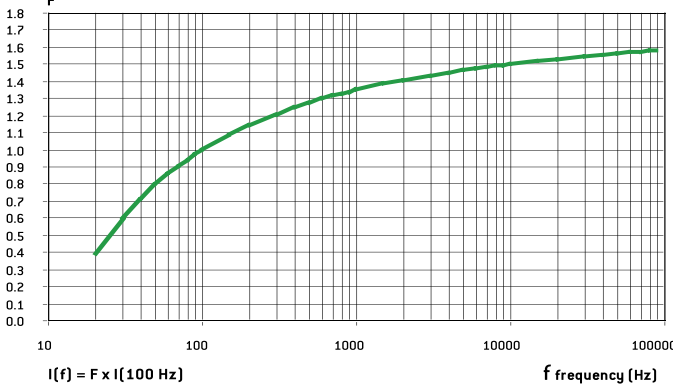
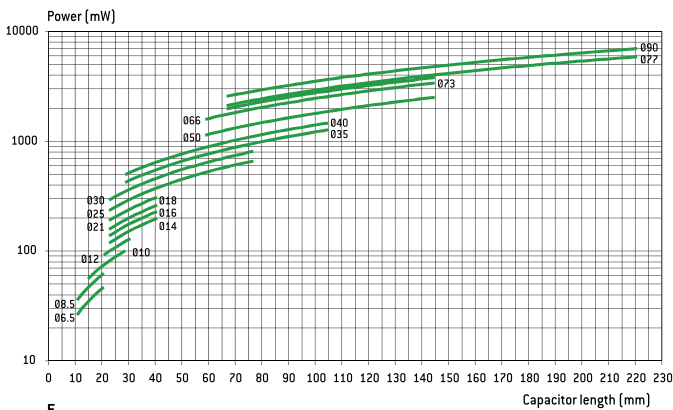

temperature rise of 10°C

$$P = ESR \cdot I^2$$

P = Dissipated power (mW)

( $\Theta_i - \Theta_a = 10^\circ\text{C}$ )

ESR: Equivalent series resistance (100 Hz 20°C)

I: Ripple current (r.m.s. value at 100 Hz)

For different frequencies from 100 Hz, I must be multiplied by the factor F, according to above chart.

### 6.4.4. Thermal resistance Rth and air cooling

Rth is static thermal resistance (without cooling) between capacitor central hot spot and ambient temperature measured at a distance of

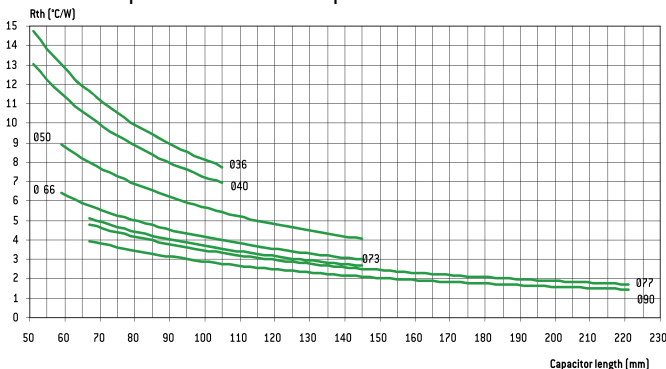

Forced or not cooling air can lead to a significant decrease of these values.

Consequently, r.m.s. ripple current can be increased as a function of air cooling speed:

Ø mm (inches)	≤ 0,5 m/s	1 m/s	2 m/s	3 m/s	≥ 4 m/s
66 - 90	1~	1,1~	1,2~	1,25~	1,3~
36 - 51	1~	1,2~	1,4~	1,45~	1,5~

This parameter shall be applied to one capacitor alone.

For capacitors in bank, ambient temperature must be strictly equal around all capacitors.

### 6.4.5. Quality guaranty

We guarantee products manufactured during 2 years from the data of shipment against defaults of material and assembly.

This guaranty can be involved by the buyer only if our products are used within normal conditions, always according to the state of the art and taking in account storage conditions.

The equipment design should take into consideration possible failures of our capacitors and related effects in order to avoid them.

Guaranty is not applicable for damages occurred by surge voltage, irregular use, polarity inversion or maintenance default.

Guaranty is exclusively limited to the replacement of individual defective capacitors within the terms of delivery. This rule applied to all cases and particularly to any further consequence of failures.

### 6.4.6. Reliability

Failure rate: \_\_\_\_\_

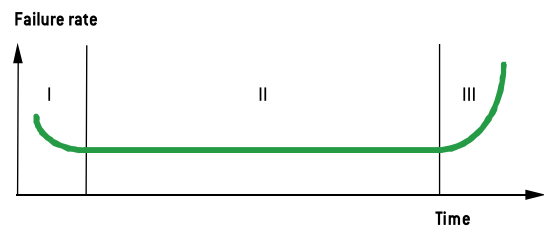

$$FR = \frac{\text{Number of components tested} \times \text{test duration}}{\text{Number of failures}}$$

Failure rate is measured in FIT (failure in time =  $10^{-9}$  / hour).

The failure rate is set up during the life time of the capacitor (phase II)

I. Early failure phase (generally excluded during ageing process).

II. Operational life time of the capacitors

III. End of life

# General technical data

Mean time between failures MTBF = 1/FR mesured in years

Range	Failure rate for a failure percentage not exceeding 1% with a confidence level of 60 %
FELSIC 85 >350 V FELSIC HC > 350 V SNAPSIC - SNAPSIC HC > 350 V SNAPSIC 4P > 350 V PROMISIC 031 Ø = 6,5 SICAL CO 42 - SICAL > 350 V	50 FIT - (MTBF = 2280)
FELSIC 037 - 039 FELSIC 85 ≤ 350 V FELSIC HC ≤ 350 V CUBISIC CI FRS SNAPSIC 105 - SNAPSIC 105 4P SNAPSIC 105 LP - SNAPSIC HV SNAPSIC - SNAPSIC 4P ≤ 350 V SNAPSIC HC ≤ 350 V ALSIC IR - ALSIC 145 - ALSIC HV - VACSIC 150 - VACSIC SICAL CO 42 - SICAL ≤ 350 V PRORELSIC 125 Ø = 6,5 RELSIC 033 PROMISIC 031 Ø > 6,5	25 FIT - (MTBF = 4560)
FELSIC 125 FRS - SNAPSIC 125 FELSIC HV - FELSIC 105	10 FIT - (MTBF = 11410)
PRORELSIC 125 Ø > 6,5 PRORELSIC 145	5 FIT - (MTBF = 22820)

Multiplying factor of FR with voltage and temperature

	Temperature (°C)							
	≤ 40	50	60	70	85	105 (1)	125 (1)	145 (1)
Factor	1	1,5	2,3	3,4	6,3	14	32	72

(1) Only for permitted capacitors

	Percentage of rated voltage (2)		
	100 %	80 %	50 %
Factor	1	0,8	0,5

(2) This voltage has to be constant

Environ- ment	Without vibration		Ground with vibrations or mob ile			
	Ground, fix Controlled air	Ground, fix	PRORELSIC SNAPSIC 20 g FELSIC 20 g	FELSIC 10 g PROMISIC SICAL Ø ≤14	CI FRS - SNAPSIC RELSIC SICAL Ø >14	ALSIC
Factor	1	2	2	4	6	12

## 7. MANUFACTURING FLOW CHART

Process controls

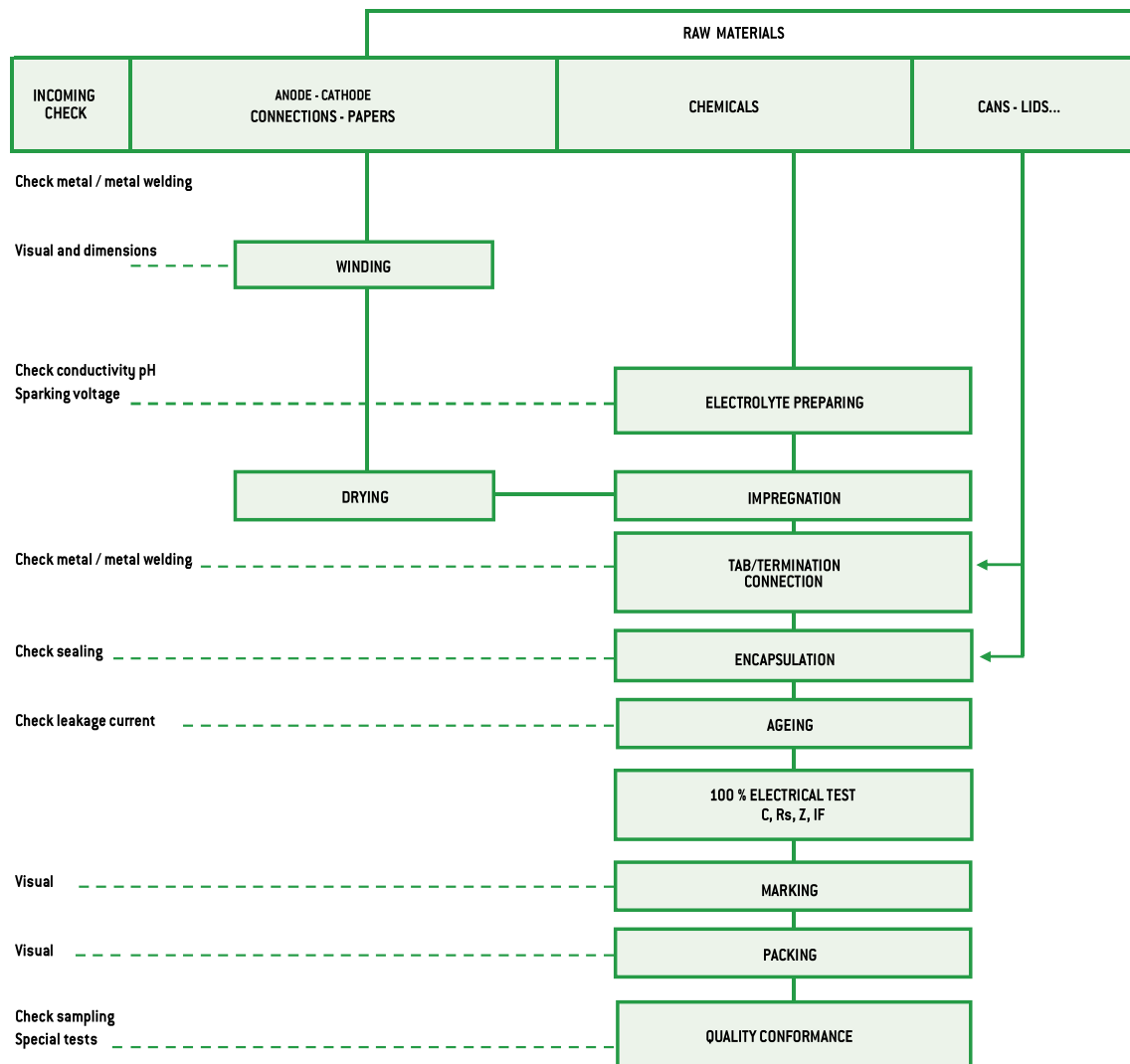



# General technical data

## 8. INFORMATION ON APPLICATION

### 8.1. CLEANING SOLVENTS

Use aliphatic alcohols, such as denatured ethyl alcohol, isopropanol, or butylacetate, or else alkaline diluted solutions. Avoid incompatible solvents (halogenous for example).

### 8.2. SHELF LIFE

There is no electrical characteristics variation for long periods of storage except leakage current which can increase.

It is caused by chemical reactions between the dielectric alumina and the electrolyte. These reactions are reversible when switched on. Capacitors can generally be stored at temperature between  $-5^{\circ}$  and  $+50^{\circ}\text{C}$  without reforming for the following periods of time:

- For  $U_R \leq 100\text{ V}$ , storage time: ..... 5 years (up to 10 years under specific conditions)
- For  $100\text{ V} < U_R \leq 360\text{ V}$  storage time: ..... 3 years
- For  $360\text{ V} < U_R < 500\text{ V}$  storage time: ..... 1 year
- For  $U_R \leq 500\text{ V}$ , storage time: ..... 6 months

Generally when these periods are overstepped, one hour at rated voltage causes the decrease of leakage current under the specified limits. An other way to avoid this leakage current increase problem is to always limit available power through capacitor during first seconds or minutes after storage or transport, according to the following chart:

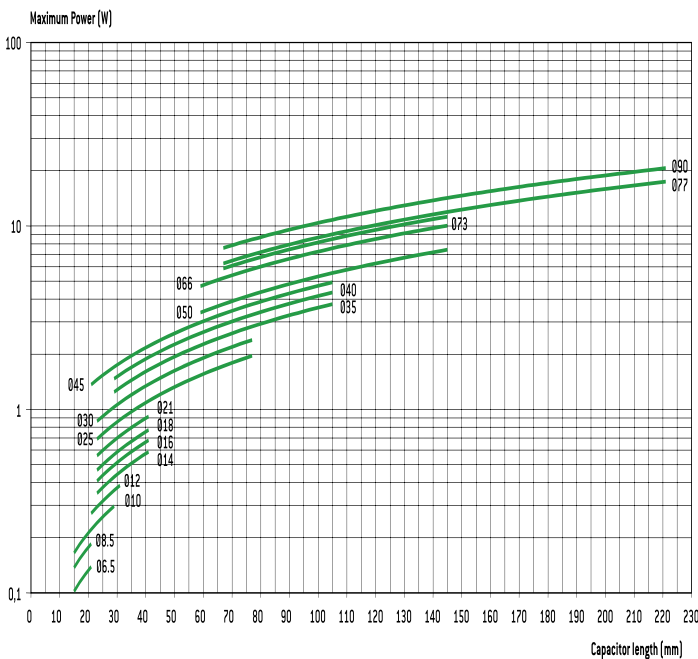

### 8.3. LOW PRESSURE RESISTANCE

EXXELIA capacitors can be used with ambient low pressure decreasing up to 10 mbar (altitude 28000 m – 92000 feet).

### 8.4. MOUNTING SCREW TERMINALS CAPACITORS (FELSIC)

Capacitors may be used vertically (terminals on top) or horizontally. When used horizontally, the following position in relation to the safety vent, is recommended:

Mounting capacitors in series may be used for operating voltage exceeding  $U_R$ . See FELSIC in bank.

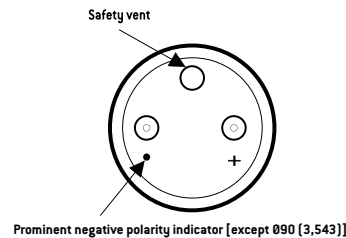

### 8.5. MOUNTING SOLDER TYPE CAPACITORS.

They may be used in any position. During mounting, avoid applying excessive force to capacitor pins or wires. There is a risk of damaging internal connections.

After soldering and for the same reasons, do not try to move the capacitor's body.

### 8.6. ELECTROLYTES: SAFETY RULES.

Electrolytes used in EXXELIA capacitors are manufactured by EXXELIA. Main solvents are generally  $\gamma$  butyrolactone and ethylene glycol, very stable high boiling point solvents. Ionic conductive salts in electrolyte induce a very weak acidity (pH 5 to 7).

### 8.7. ENVIRONMENT.

In aluminium capacitors with liquid electrolyte there is no component showing a pollution risk, in small amounts, of air or water. EXXELIA is always involved in this security field particularly in using chemicals for electrolyte, without well-known risks.

- Dimethylformamide (DMF) dangerous solvent forbidden in several uses is completely excluded by EXXELIA, since 1990.
- There is no halogen compound such as chlorofluorocarbon (CFC or FCKW in German) or polychlorobiphenyl (PCBPyrallene) or pentabromodiphenylether or octabromodiphenylether.

There is neither benzene, toluene or phenyl compound nor explosive such as picric acid, nor asbestos in plastic covers. All the capacitors made by EXXELIA since 1991, can be scrapped or used in raw materials recycling processes without special care in compliance with Community rules.

EXXELIA aluminium capacitors with non-solid electrolyte are particularly suitable for different kinds of environment taking in account severity increasing laws.

European directives 2003/11/EC, 2002/96/EC (WEEE) and 2002/95/EC (RoHS) applies to all EXXELIA capacitors including every solder type, manufactured with pure tin coated pins or wires, since at least January 2006.

# Mounting and insulating parts

## STUD FIXING: FELSIC BD

Steel nut, spring washer and insulating washer are delivered loosely with the capacitor.

### STANDARD MOUNTING WITH:

Insulating washer and steel nut

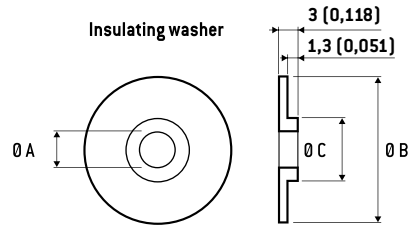
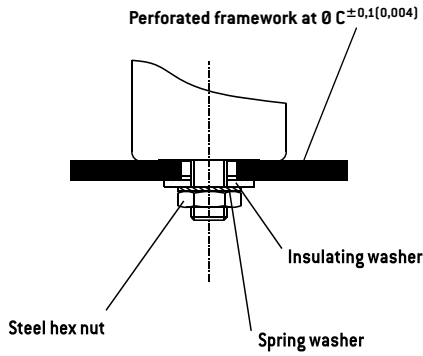

Ø Capacitor	DIMENSIONS in mm (inches)				Code
	M	Ø A	Ø B	Ø C	
36	8	8,4	25	18,5	A 691060
51 - 77	12	12,5	30	21,5	A 691061
90	12	12,5	35	21,5	A 691062

Insulating plastic nut with or without insulating washer

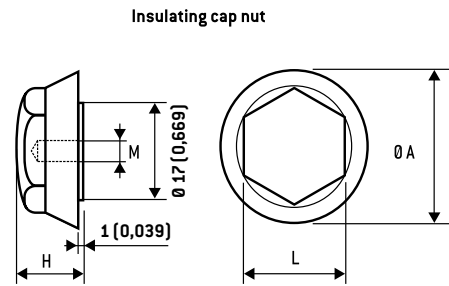
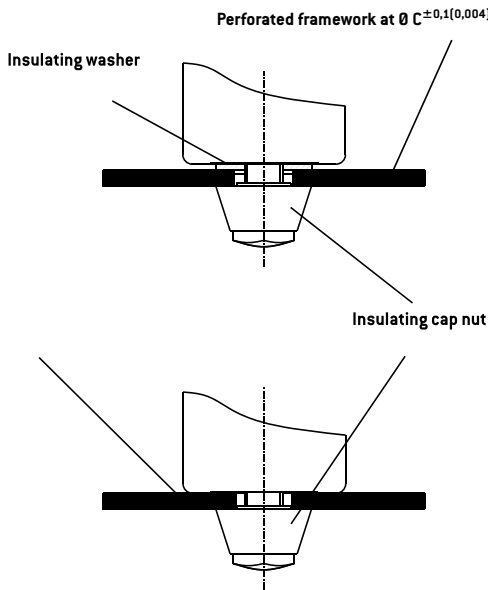

DIMENSIONS in mm (inches)					
M	Ø A	H	L	Max. torque	Code
8 (0,315)	25 (0,984)	15 (0,591)	17 (0,669)	3 Nm	A 691070
12 (0,472)	30 (1,181)	20 (0,787)	19 (0,748)	7 Nm	A 691071

## Ring - clip mounting: FELSIC LP

Ring clips shall be ordered separately.

Tightening screws and nuts are supplied loosely.

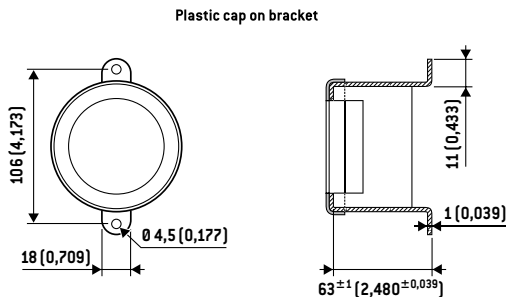

FELSIC 85 LP FELSIC 105 LP	Code
Metal bracket	A691055
Plastic cap	A691065

# General technical data

Ring - clip mounting: FELSIC BC

Ring clips shall be ordered separately.

Tightening screws and nuts are supplied loosely.

## FELSIC BC - Metal ring-clips

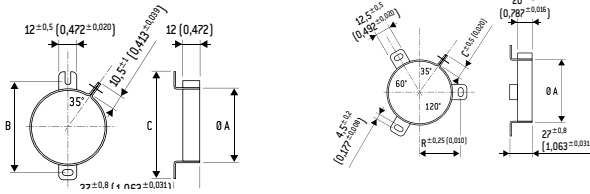

Ø A Cap.	B	C	Code	Ø A Cap.	B	C	Code
36	54	63	A 691901	51	33,5	11,8	A 691905
				66	39	10,5	A 691913
				73	44	10,5	A 691914
				77	44,5	10,5	A 691907
				90	53,3	11,8	A 691915

Stirrup mounting: CUBISIC LP

Stirrups shall be ordered separately.

Tightening screws and nuts are supplied loosely

Salt mist endurance of screws and mounting accessories:  
minimum 96 h (IEC 600 68-2-11)

## CUBISIC /CUBISIC LP - Metal bracket

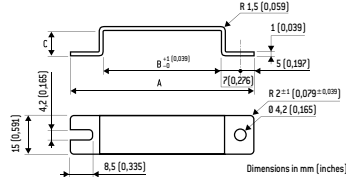

Ø A Cap.	A	B	C	Code
45x12 (1,772x0,472)	69 (2,717)	45 (1,772)	10 (0,394)	A 691057
35x16 (1,378x0,630)	59 (2,323)	35 (1,378)	14 (0,551)	A 691059

## PACKAGING

### 1. PACKAGING AND WEIGHT UNITS.

#### 1.1. Capacitor with screw terminals

Can DIMENSIONS in mm (inches)				Unit weight *
Ø	H			(g)
36 (1,417)	47 (1,850)	52 (2,047)	53 (2,087)	70
36 (1,417)	60 (2,362)			79
36 (1,417)	80 (3,150)	81 (3,189)		100
36 (1,417)	104 (4,094)	105 (4,134)		120
51 (2,008)	47 (1,850)			80
51 (2,008)	62 (2,441)	63 (2,480)		105
51 (2,008)	81 (3,189)	82 (3,228)		190
51 (2,008)	104 (4,094)	105 (4,134)		260
51 (2,008)	112 (4,409)			270
51 (2,008)	144 (5,669)			370
66 (2,598)	104 (4,094)	105 (4,134)		430
66 (2,598)	112 (4,409)			460
73 (2,874)	104 (4,094)	112 (4,409)		600
73 (2,874)	144 (5,669)			680
77 (3,031)	104 (4,094)	105 (4,134)		620
77 (3,031)	144 (5,669)	145 (5,709)		860
77 (3,031)	200 (7,874)			1300
77 (3,031)	220 (7,874)	221 (8,701)		1400
90 (3,543)	67 (2,638)			600
90 (3,543)	144 (5,669)	145 (5,709)		1400
90 (3,543)	200 (7,874)			1800

\* Unit weight = typical values

Possible variations of = ± 25 % according to different voltage and capacitance.

#### 1.2. Radial solder types

Can dimensions mm (inches)		ALSIC	SNAP-SIC	Can dimensions		AL-SIC	SNAP-SIC
Ø	H	Weight* (g)		Ø	H	Weight* (g)	
10 (0,394)	16 (0,630)	1,8	-	35 (1,378)	30 (1,181)	-	50
12,5 (0,492)	21 (0,827)	4,5	-	35 (1,378)	40 (1,575)	-	50
12,5 (0,492)	24 (0,945)	5	-	35 (1,378)	45 (1,772)	-	52
				35 (1,378)	50 (1,969)	-	60
16 (0,630)	25 (0,984)	8,2	-	35 (1,378)	75 (2,953)	-	95
				35 (1,378)	100 (3,937)	-	125
22 (0,866)	25 (0,984)	-	15	40 (1,575)	40 (1,575)	-	65
22 (0,866)	30 (1,181)	-	17	40 (1,575)	50 (1,969)	-	100
22 (0,866)	40 (1,575)	-	18	40 (1,575)	75 (2,953)	-	130
				40 (1,575)	100 (3,937)	-	170
25 (0,984)	25 (0,984)	-	17	45 (1,772)	21 (0,827)	-	50
25 (0,984)	30 (1,181)	-	20	45 (1,772)	30 (1,181)	-	60
25 (0,984)	35 (1,378)	-	22	45 (1,772)	35 (1,378)	-	73
25 (0,984)	40 (1,575)	-	25	45 (1,772)	45 (1,772)	-	85
25 (0,984)	45 (1,772)	-	28	45 (1,772)	45 (1,772)	-	110
25 (0,984)	50 (1,969)	-	30	45 (1,772)	75 (2,953)	-	180
				45 (1,772)	100 (3,937)	-	240
30 (1,181)	25 (0,984)	-	28				
30 (1,181)	30 (1,181)	-	30				
30 (1,181)	35 (1,378)	-	30				
30 (1,181)	40 (1,575)	-	40				
30 (1,181)	45 (1,772)	-	45				
30 (1,181)	50 (1,969)	-	50				

Can DIMENSIONS in mm (inches)			CUBISIC
I	L	H	weight (g)
35 (1,378)	35 (1,378)	16 (0,630)	30
35 (1,378)	50 (1,969)	16 (0,630)	40
45 (1,772)	35 (1,378)	12 (0,472)	30
45 (1,772)	50 (1,969)	12 (0,472)	45
45 (1,772)	75 (2,953)	12 (0,472)	60

\* Unit weight = typical values

Possible variations of = ± 25 % according to different voltage and capacitance.

#### 1.3. Axial types

Can DIMENSIONS in mm (inches)		PRORELSIC RELSIC	PRORELSIC PROMISIC	SICAL CO 42 SICAL
Ø	H	Unit weight * (g)	Unit weight * (g)	Unit weight * (g)
6,5 (0,256)	15 (0,591)	-	1,6	-
6,5 (0,256)	19 (0,748)	-	1,8	1,8
8,5 (0,335)	19 (0,748)	-	2,3	2,3
10 (0,394)	19 (0,748)	-	2,8	2,8
10 (0,394)	25 (0,984)	-	3,5	3,5
10 (0,394)	28 (1,102)	-	3,8	-
12 (0,472)	25 (0,984)	-	5	-
12 (0,472)	30 (1,181)	-	5,4	5,4
14 (0,551)	30 (1,181)	-	6,9	6,9
14 (0,551)	41 (1,614)	-	9,5	-
	30 (1,181)	7,7	-	7,7
18 (0,709)	35 (1,378)	13,6	-	-
18 (0,709)	40 (1,575)	15,3	-	15,3
21 (0,827)	40 (1,575)	19,5	-	19,5
25 (0,984)	40 (1,575)	28	-	28
25 (0,984)	50 (1,969)	35	-	35
25 (0,984)	75 (2,953)	56	-	56

\* Unit weight = typical values

Possible variations of = ± 25 % according to different voltage and capacitance.

# General technical data

## 2. PACKAGING ON TAPE

### 2.1. Axial types

Dimensions and tolerance in accordance with IEC 60 286-

(1) On tape only on request

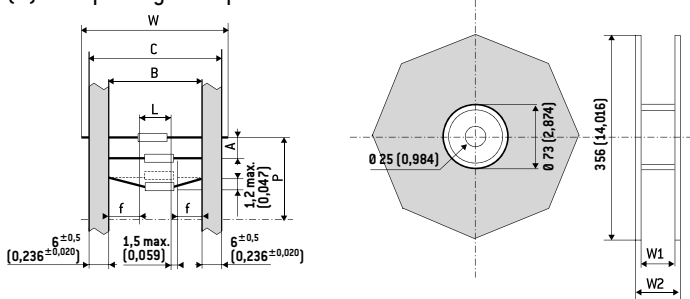

DIMENSIONS in mm (inches)									
D	L max.	B	A	P	C max.	W <sub>1</sub>	W <sub>2</sub> max.	W	n <sup>(2)</sup>
6,5 (0,256)	20 (0,787)	73 <sup>±1,5</sup>	10 <sup>±1,5</sup>	± 2 (0,079)	87,5 (3,445)	93 (3,661)	106 (3,661)	85 <sup>±1,5</sup>	1000 (39,370)
8,5 (0,335) <sup>(1)</sup>		(2,874 <sup>±0,059</sup> )	(0,394 <sup>±0,059</sup> )					(3,346 <sup>±0,059</sup> )	750 (29,528)
10 (0,394) <sup>(1)</sup>	32 (1,260)	73 <sup>±1,5</sup>	15 <sup>±1,5</sup>	± 3 (0,118)	87,5 (3,445)	93 (3,661)	106 (3,661)	85 <sup>±1,5</sup>	400 (15,748)
12 (0,472) <sup>(1)</sup>		(2,874 <sup>±0,059</sup> )	(0,591 <sup>±0,059</sup> )					(3,346 <sup>±0,059</sup> )	400 (15,748)
14 (0,551) <sup>(1)</sup>									200 (7,874)

(2) n = number of capacitors per reel.

White positive tape f: > 20 mm (0,787 inches)

P: 10 space